

# The SMRT Series for Protective Relay Testing



**SMRT410** Multi Phase Relay Test System

**SMRT36** Three Phase Relay Test System

**SMRT33** Three Phase Relay Test System

**SMRT1** Single Phase Relay Test System

**STVI** Smart Touch View Interface

Software runs on the STVI or on a PC

**AVTS** Advanced Visual Test Software, 4.1

**Megger**<sup>®</sup>

[www.megger.com/us](http://www.megger.com/us)

To receive a copy of our latest booklet, *IEC 61850 GOOSE – Interoperability New Problems and New Solutions*, contact us at [sales@megger.com](mailto:sales@megger.com)

The word "Megger" is a registered trademark

# SMRT410

## Megger Relay Test System



SMRT410 with 6 x 60 Amps

- **Small, rugged, lightweight and powerful**
- **Operates with or without a computer**
- **Intuitive manual operation with Smart Touch View Interface**
- **High current, high power output (60 Amps/300 VA rms) per phase**
- **Flexible output design provides up to four-phase voltage and up to ten-phase current**
- **Network interface provides IEC 61850 test capabilities**
- **Fully automated testing using AVTS software**

### DESCRIPTION

The SMRT410 has the “smart” combination of high compliance voltage and high current output to test all electromechanical, solid-state and microprocessor-based overcurrent relays, including; voltage controlled, voltage restraint and high impedance directional ground overcurrent.

The SMRT410 provides a complete multi-phase test system for commissioning of protection systems. With up to 4 voltage channels and 6 high current channels, the SMRT410 meets every testing need. The SMRT410 VIGEN modules also provide high power in BOTH the voltage and current channels to test virtually all types of protective relays. The SMRT410 test system may be customized by adding the number of Voltage-Current, “VIGEN”, modules needed for specific test applications.

The SMRT410 test system has the ability to be manually controlled with Megger’s new Smart Touch View Interface™ (STVI). The STVI, with its large, full color, high resolution, TFT LCD touch screen allows the user to perform manual, steady-state and dynamic



STVI with SMRT410

testing quickly and easily using the manual test screen, as well as using built-in preset test routines for most popular relays.

The STVI eliminates the need for a computer when testing virtually all types of relays. Menu screens and touch screen function buttons are provided to quickly and easily select the desired test function. Tests results can be saved to the STVI for download to a memory stick to transfer or print test reports.

For full automatic testing the SMRT410 may be controlled by Megger Advanced Visual Test Software (AVTS). AVTS is a Microsoft® Windows® XP®/Vista™/7/8 compatible software program designed to manage all aspects of protective relay testing using the new Megger SMRT.

### APPLICATIONS

Each current channel is rated for 30 Amps @ 200 VA continuous, up to 60 Amps @ 300 VA for short durations. It has a unique flat power curve from 4 to 30 Amps that insures maximum compliance voltage to load at all times. With only 3 currents in parallel the unit provides up to 180 Amps @ 900 VA for instantaneous tests. With a maximum compliance voltage of 50 Volts per phase, just two channels in series provide 100 Volts of compliance voltage to test high impedance relays.

Each voltage channel can provide variable outputs of 0- 30/150/ 300 Volts at 150 VA of output power, and has a unique flat power curve from 30 to 150 Volts insuring maximum output power to the load at all times. With the voltage channels converted to current, a five channel unit can provide 10 currents.

Using the Ethernet ports, the SMRT410 is literally a “plug-and-play” unit, where voltage and current outputs can be seamlessly synchronized with other SMRT units outputs for testing more complex test applications such as back-to-back tests.



**FEATURES AND BENEFITS**

**Constant Power Output** – New higher powered Voltage-Current amplifiers. The current amplifier delivers maximum compliance voltage to the load constantly during the test, and range changing is done automatically under load. This insures better test results, and saves time by not having to turn the outputs off to change ranges. Constant power output in many cases eliminates the need to parallel or series current channels together to test high burden relays.

**High Output Current** – Provides up to 30 Amps at 200 VA per phase continuous, or up to 60 Amperes at 300 VA with a 1.5 second duty cycle. With only three current amplifiers in parallel the SMRT410 provides 180 Amperes at 900 VA, for testing all instantaneous overcurrent relays.

**New PowerV™ Voltage Amplifier High Power Output** – The SMRT provides a new higher VA power output on the voltage channel at the lower critical test voltages (from 30 to 150 Volts). Customers who want to test a panel of relays at one time find it impossible using lower VA rated voltage.

**Convertible Voltage Channels** – With a 5 channel SMRT410 unit, convertible channels in conjunction with the main current channels, provides 10 currents for testing multi-phase current differential relays.

**High resolution and accuracy** – Metered outputs provides extremely high accuracy needed for testing a wide variety of devices. With metered values, what you see is what you get.

**Steady-State and Dynamic testing capability** – The SMRT410 provides, either through manual control or computer control, both steady-state and dynamic testing of protective relays. This includes programmable waveforms with dc offset and harmonics.

**Output current and voltage sine waves are generated digitally** – Outputs do not vary with sudden changes in input voltage or frequency, which increases test accuracy and reduces testing time.

**Digital binary inputs and outputs** – The programmable binary inputs, and programmable outputs provide timing and logic operations in real-time with the output voltage and currents. Binary Inputs can be programmed, using Boolean logic, for more complex power system simulations. This provides a low cost, closed loop, power system simulator.

**Circuit breaker simulator** – Binary outputs provide programmable normally closed and normally open contacts to simulate circuit breaker operation for testing reclosing relays. Sequence of operation, timing, and lockout are easily tested.

**Performs transient tests** – Perform acceptance or troubleshooting tests by replaying digitally recorded faults or EMT/ATP simulations in the IEEE- C37.111, COMTRADE Standard format.

**Perform End-to-End tests** – Using AVTS software and a portable GPS satellite receiver, the SMRT performs satellite-synchronized end-to-end dynamic multi-state or playback transient COMTRADE files either for commissioning or troubleshooting tests.

**Wide-ranging output frequency** – The output frequency of the current and voltage channels can be set for any frequency from dc to 1 kHz. Popular test frequencies such as 16.66, 25, 33, 50, 60, 100, 120, 125, 150, 180, 250, 300 and 400 Hz are easily set and controlled. Multi-purpose test system saves time and money.

**USB 2.0 interface port** – The USB port provides a PC interface for automated control of the SMRT unit. Also provides secure isolation when testing IEC 61850 devices (for customers who require secure isolation from their IEC 61850 substation bus).

**Three Ethernet ports** – PC/OUT Ethernet Port is the primary PC connection port. The IN/IEC61850 Ethernet Port provides interface to multiple SMRT units, and may be used to connect to the IEC 61850 substation bus. The OUT Ethernet Port is primarily used to interconnect multiple SMRT units together for synchronous multi-unit operation. The STVI PoE (Power over Ethernet) port and is used to connect to the STVI.

**Bluetooth** – Optional Bluetooth provides more flexibility. A wireless interface between the PC and SMRT, in conjunction with the SMRT IEC 61850 Ethernet port, provides the isolation required for a secure substation access interface between the SMRT and the IEC 61850 substation network.

**Universal input voltage** – Operation from 90 to 264 Vac, 50/60 Hz, the SMRT can use virtually any standard source in the world.

**Immediate error indication** – Audible and visual alarms indicate when amplitude or waveforms of the outputs are in error.

**Modular design** – Output modules plug-in and out easily for system re-configuration and maintenance.

**IEC 61850** – Optional integrated interface provides testing using the IEC 61850 GOOSE protocol.

**Optional Transducer Testing Capability** – This optional hardware feature (see Ordering Information) provides transducer DC Inputs to test transducers easily and effectively. The STVI software is designed to automatically recognize the Transducer DC Inputs, and thus provide the Transducer Test Screen when selected. AVTS software comes standard with Transducer Test Modules, which will provide automatic transducer test capability in conjunction with the optional hardware.

SMRT410 RELAY TESTER

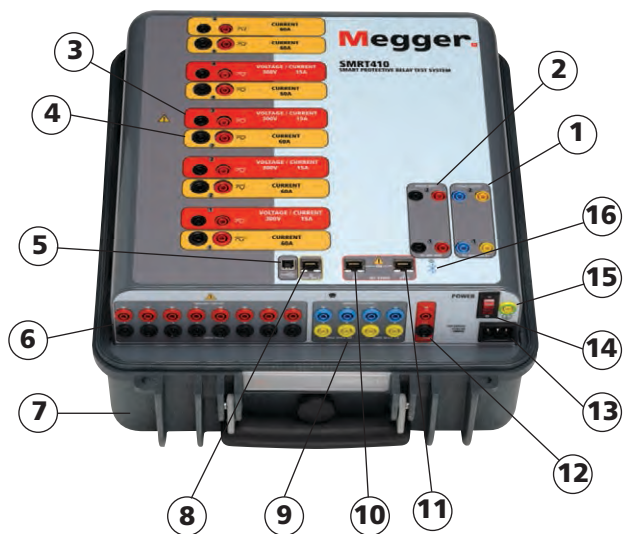

- 1. **Binary Outputs 1 and 2:** Rated for 300 V at 8 Amps.
- 2. **Binary Inputs 1 and 2:** Rated 5 to 300 V AC/DC
- 3. **Voltage Outputs:** Up to 4 channels 300 V at 150 VA, convertible to currents 15 A at 120 VA per phase.
- 4. **Current Outputs:** Up to 6 channels 60 Amps at 300 VA per phase.
- 5. **USB 2.0 Interface:** Communication and control port.
- 6. **Additional Binary Inputs:** Provides 8 additional monitor circuits.
- 7. **Rugged Case:** Fiberglass reinforced plastic.
- 8. **PC/OUT:** Ethernet Port is the primary PC connection port. Ethernet Port used to chain multiple SMRT units together for synchronous multi-unit operation.
- 9. **Additional Binary Outputs:** Adds 4 outputs. Binary Outputs 3 and 4 are rated for 300 V AC/DC, 8 amperes. Binary Outputs 5 and 6 are high speed and have an AC/DC voltage rating of 400 volts peak, 1 ampere.
- 10. **IN/61850:** This port may also be used for connecting to the IEC 61850 substation bus for testing IEC 61850 devices.
- 11. **STVI:** Ethernet Port is a PoE (Power over Ethernet) port and is used to connect to the STVI for manual control.
- 12. **Battery Simulator:** Variable 5 to 250 Volts DC output at 100 Watts (4 amperes maximum).
- 13. **Incoming Power/Line Cord Socket:** 100 to 240 V, 50/60 Hz.
- 14. **POWER ON/OFF Switch:** Illuminates when power is on.
- 15. **Protective Earth Ground Jack.**
- 16. **Bluetooth:** Bluetooth® provides wireless control.

APPLICATIONS SELECTION GUIDE

Protective Relays by IEEE Device #		SMRT410 Three Channels	SMRT410 Four Channels
2	Time Delay	■	■
21	Distance Single Phase	■	■
21	Distance Three Phase Open Delta	■	■
21	Distance Three Phase wye	■	■
24	Volts/Hz	■	■
25	Synchronizing	■	■
27/59	Under/Over Voltage	■	■
32	Directional Power Single Phase	■	■
32	Directional Power Three Phase	■	■
37/76	DC Under/Over Voltage/Current	■	■
40	Loss of Field	■	■
46	Phase Balance Current	■	■
46N	Negative Sequence Overcurrent	■	■
47	Phase Sequence Voltage	■	■
50	Instantaneous Overcurrent	Up to 225 Amps	Up to 300 Amps
51	Time Delay Overcurrent	Up to 105 Amps	Up to 140 Amps
55	Power Factor	■	■
60	Voltage/Current Balance	■	■
67	Directional Overcurrent	■	■
67N	Ground Directional Overcurrent	■	■
78	Out of Step	■	■
79	Reclosing	■	■
81	Frequency	■	■
85	Carrier or Pilot Wire	■	■
87	Differential	■	■
91	Voltage Directional	■	■
92	Voltage and Power Directional	■	■
94	Tripping	■	■

**SPECIFICATIONS<sup>1</sup>**

**Input Power**

100 to 240 Volts (± 10%) AC, 1Ø, 50/60 Hz, 1800 VA

**Outputs<sup>2</sup>**

All outputs are independent from sudden changes in mains voltage and frequency, and are regulated so changes in load impedance do not affect the output. All amplifier outputs are isolated or floating. The SMRT units can be ordered with the amplifier common returns tied to chassis ground as an option.

**Output Current Sources**

The SMRT410 with five modules can provide up to ten current sources; six high current/high power<sup>3</sup>, and four convertible channels providing lower current/high power. The per channel output current and power ratings are specified in AC rms values and peak power ratings.

Output Current	Power	Max V/Duty Cycle
1 Ampere	15 VA	15.0 Vrms Continuous
4 Amperes	200 VA (282 peak)	50.0 Vrms Continuous
15 Amperes	200 VA (282 peak)	13.4 Vrms Continuous
30 Amperes	200 VA (282 peak)	6.67 Vrms Continuous
60 Amperes	300 VA (424 peak)	5.00 Vrms 90 Cycles
DC	200 Watts	

**With three currents in parallel:**

Output Current	Power	Max V/Duty Cycle
12 Amperes	600 VA (848 peak)	50.0 Vrms Continuous
45 Amperes	600 VA (848 peak)	13.4 Vrms Continuous
90 Amperes	600 VA (848 peak)	6.67 Vrms Continuous
180 Amperes	900 VA (1272 peak)	5.00 Vrms 90 Cycles

**With two currents in series:**

The compliance voltage doubles to provide 4.0 Amperes at 100 Volts rms.

**Current Amplifier - Extended Power Range**

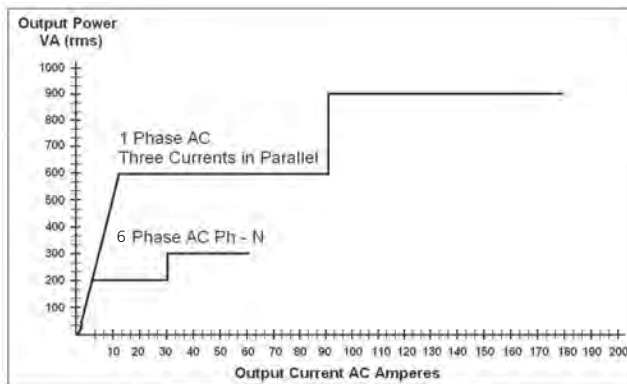

Current Amplifier Output Power Curve

The SMRT current amplifier provides a unique flat power curve from 4 to 30 Amperes per phase to permit testing of electromechanical high impedance relays, and other high burden applications, with an extended operating range up to 60 Amperes at 300 VA rms.

**AC Voltage Output**

Outputs are rated with the following Ranges:

Output Volts	Power	Max I
30 Volts	150 VA	5 Amps
150 Volts	150 VA	Variable <sup>4</sup>
300 Volts	150 VA	0.5 Amps
DC	150 Watts	

**Duty Cycle:** Continuous

**With two voltages in series**

The output voltage and power doubles to provide 600 volts at 300 VA.

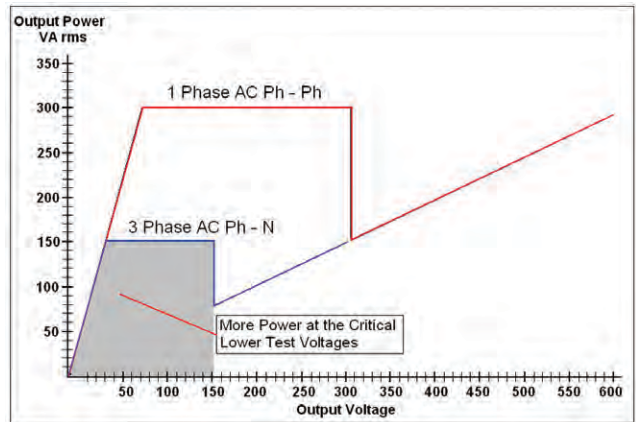

"PowerV" Voltage Amplifier Output Power Curves

**"PowerV"<sup>TM</sup> Voltage Amplifier - Extended Power Range**

The SMRT voltage amplifier provides a flat power curve from 30 to 150 Volts in the 150V range to permit testing of high current applications such as panel testing.

**Voltage Amplifier in Current Mode:**

The voltage amplifier is convertible to a current source with the following output capability. Output power ratings are specified in rms values and peak power ratings.

Output Current	Power	Max V	Duty Cycle
5 Amperes	150 VA (212 peak)	30.0 Vrms	Continuous
15 Amperes	120 VA	8.0 Vrms	90 Cycles

**Phase Angle**

**Ranges:** 0.00 to 359.99 degrees, Counter Clock Wise, or Clock Wise rotation, or 0.00 to ±180.00 degrees

**Accuracy:** ±0.02° typical, ±0.25° max at 50/60 Hz

**Frequency**

The output modules provide a variable frequency output with the following ranges and accuracy.

**Ranges**

DC  
0.001 to 1000.000 Hz

Output amplifiers can provide transient signals with a range of DC to 10 kHz for transient playback using COMTRADE files.

**Resolution\*:** .0001/.001 Hz

**Frequency Accuracy:**

2.5 ppm typical  
25 ppm 0° to 50° C, at 50/60 Hz Maximum

<sup>1</sup> Megger reserves the right to change product specifications at any time.

<sup>2</sup> For 4 VIGEN modules, with or without DIGEN modules, operating at input voltages below 200 VAC a derating of the simultaneously available total output power of the voltage/current amplifiers and battery simulator will occur. The maximum output power of a single amplifier is not affected.

<sup>3</sup> Six high current/high power channels require optional DIGEN, Double Current Generation, see Ordering Information for details.

<sup>4</sup> PowerV<sup>TM</sup> voltage amplifier output current varies depending on the voltage setting on the 150 Volt range, see curve.

**Total Harmonic Distortion**

Less than 0.1% typical, 2% maximum at 50/60 Hz

**Timer**

The Timer-Monitor Input is designed to monitor and time-tag inputs, like a sequence of events recorder. In addition, the binary input controls enable the user to perform logic AND/OR functions, and conditionally control the binary output relay to simulate circuit breaker, trip, reclose and carrier control operation in real-time. The Timer function displays in Seconds or Cycles, with the following range and resolution:

**Seconds:** 0.0001 to 99999.9

**(Auto Ranging)**

**Cycles:** 0.01 to 99999.9

**(Auto Ranging)**

**Accuracy:**  $\pm 0.001\%$  of reading, typical.  $\pm 2$  least significant digit,  $\pm 0.005\%$  of reading from 0 to 50° C maximum

**Binary Input – Start/Stop/Monitor Gate**

To monitor operation of relay contacts or trip SCR, continuity light is provided for the input gate. Upon sensing continuity, or voltage applied, the lamp will glow. In addition to serving as wet/dry contacts the Binary Inputs may be programmed to trigger binary output sequence(s).

**Input Rating:** up to 300 V AC/DC

**Binary Output Relays**

SMRT410 has independent, galvanically isolated, output relay contacts to accurately simulate relay or power system inputs to completely test relays removed from the power system. The binary output simulates normally open / normally closed contacts for testing breaker failure schemes. The binary output can be configured to change state based on binary input logic.

**High Current Output Relays:** The first two VIGEN Modules have 1 each and the P option add 2 more.

**AC Rating:** 400 V max., I<sub>max</sub>: 8 amps, 2000 VA max.

**DC Rating:** 300 V max., I<sub>max</sub>: 8 amps, 80 W

**Response Time:** <10ms

**High Speed Output Relays:** SMRT410 P Option adds 2

**AC/DC Rating:** 400 V peak, I<sub>max</sub>: 1 amp

**Response Time:** <1ms typical

**Battery Simulator**

The SMRT410 with the P (Plus) option includes a battery simulator with a variable DC output voltage ranging from 5 to 250 Volts at 100 Watts, 4 Amps max, providing capability to power up relays with redundant power supplies. Voltage output is controlled via the Smart Touch View Interface, or through AVTS software. The SMRT410 with the N option does not include a battery simulator.

**Waveform Generation**

Each output channel can generate a variety of output waveforms such as: DC; sine wave; sine wave with percent harmonics at various phase angles; half waves; square waves with variable duty cycles; exponential decays; periodic transient waveforms from digital fault recorders, relays with waveform recording capability or EMTP/ATP programs, which conform to the IEEE C37.111 COMTRADE standard format.

**Metering**

Measured output quantities such as AC Amperes, AC Volts, DC Volts or DC Amperes, and Time may be simultaneously displayed on the large, color TFT LCD touch screen. The AC and DC outputs display the approximate voltage/current output prior to initiation of the outputs. All accuracies stated are from 10 to 100% of the range at 50/60Hz.

**AC Voltage Amplitude**

**Accuracy:**  $\pm 0.05\%$  reading + 0.02 % range typical,  $\pm 0.15\%$  reading + 0.05 % range maximum

**Resolution:** .01

**Measurements:** AC RMS

**Ranges:** 30, 150, 300V

**AC Current Amplitude**

**Accuracy:**  $\pm 0.05\%$  reading + 0.02 % range typical,  $\pm 0.15\%$  reading + 0.05 % range maximum

**Resolution:** .001/.01

**Measurements:** AC RMS

**Ranges:** 30, 60A

**DC Voltage Amplitude**

**Accuracy:** 0.1% range typical, 0.25% range maximum

**Resolution:** .01

**Measurements:** RMS

**Ranges:** 30, 150, 300V

**DC Current Amplitude**

**Accuracy:**  $\pm 0.05\%$  reading + 0.02 % range typical,  $\pm 0.15\%$  reading + 0.05% range maximum<sup>5</sup>

$\pm 0.15\%$  reading + 0.20% range maximum<sup>6</sup>

**Resolution:** .001/.01

**Measurements:** RMS

**Ranges:** 30A

**Convertible Source in AC Current Mode**

**Accuracy:**  $\pm 0.05\%$  reading + 0.02% range typical,  $\pm 0.15\%$  reading + 0.05 % range or  $\pm 12.5$  mA whichever is greater

**Resolution:** .001

**Measurements:** AC RMS

**Range:** 5, 15A

**DC IN Inputs (Optional Transducer Feature)****DC IN Volts**

**Range:** 0 to  $\pm 10$  V DC

**Accuracy:**  $\pm 0.001\%$  reading + 0.005% range Typical  $\pm 0.003\%$  reading + 0.02% range Max

**Resolution:** .001

**Measurements:** Average

**DC IN Amperes**

**Range:** 0 to  $\pm 1$  mA DC

4 to  $\pm 20$  mA DC

**Accuracy:**  $\pm 0.001\%$  reading + 0.005% range Typical  $\pm 0.003\%$  reading + 0.02% range Max

**Resolution:** .001

**Measurements:** Average

**Environmental**

**Operating Temperature:** 32 to 122° F (0 to 50° C)

**Storage Temperature:** -40 to 158° F (-40 to 70° C)

**Relative Humidity:** 5 - 95% RH, Non-condensing

**Unit Enclosure**

The SMRT unit comes housed in a rugged, virtually indestructible, lightweight and ergonomic enclosure. It features a large oversized rubber cushioned handle, and removable lid for use in tight spaces.

**Dimensions****With the lid on:**

14.2 W x 7.6 H x 16.25 D in.  
(360 W x 194 H x 413 D mm)

**With the lid off:**

14.2 W x 7.2 H x 16.25 D in.  
(360 W x 180 H x 413 D mm)

**IEC Enclosure Rating:** IP20

**Weight**

**With the transit lid on:** 39.5 lb. (17.76 kg)

**With the transit lid off:** 36.5 lb. (16.4 kg)

**Conformance Standards**

**Safety:** EN 61010-1

**Shock:** MIL-PRF-28800F (30 g/11ms half-sine)  
IEC 60068-2-27 (15 g/11 ms half-sine)

**Vibration:** MIL-PRF-28800F (10-500 Hz, 2.05 g rms)  
IEC 60068-2-6 (10-150 Hz, 2 g)

**Transit Drop:** MIL-PRF-28800F (10 drops, 46 cm), ISTA 1A

**Electromagnetic Compatibility**

**Emissions:** EN 61326-2-1, EN 61000-3-2/3,  
FCC Subpart B of Part 15 Class A

**Immunity:** EN 61000-4-2/3/4/5/6/8/11

**Protection**

Voltage outputs are protected from short circuits and thermally protected against prolonged overloads. Current outputs are protected against open circuits and thermally protected against prolonged overloads.

**Communication Interfaces**

Ethernet (3)

USB 2.0

Bluetooth (optional)

**SOFTWARE****AVTS – STVI Basic**

Every unit comes with **AVTS Basic** software and the PC version of the **STVI Basic** software packages. AVTS Basic version includes Online Vector control (for single and multi-state timing tests), Online Ramp control (for automatic ramping of voltage, current, phase angles or frequency) and Online Click-On-Fault (for dynamic tests of impedance relays). Test results may be exported directly to Microsoft Word. AVTS software includes a database for saving test results, which can also provide the necessary information needed for system reliability audits. See **AVTS** bulletin for more information.

The PC version of the STVI software includes the ability to bring all STVI test data (from other STVI units) into file folders for retrieval, review and printing whenever needed. See **STVI** bulletin for more information.

**AVTS Advanced**

The AVTS Advanced version includes all the feature in AVTS Basic plus the powerful Test Editor, Dynamic Control (includes dynamic end-to-end testing capability, and waveform recording capability), ASPEN OneLiner™ or Electrocon CAPE™ SS1 File Converter for dynamic testing, and easy to use programming Tools for creating and editing test modules. See **AVTS** bulletin for more information.

**AVTS Professional**

The AVTS Professional version includes all of the features of the Basic and Advanced versions plus some other powerful test tools and features. It includes the DFR Waveform Viewer, One-Touch™ Test for fully automatic tests, Modbus communication test capability, and Waveform Digitizer to digitize scanned waveforms of electromechanical over current time curves. See **AVTS** bulletin for more information.

**IEC 61850 GOOSE**

The SMRT with the GOOSE enabled, in conjunction with the Megger GOOSE Configurator (MGC) software, can be used in the testing or commissioning of IEC 61850 compliant devices. See **AVTS** bulletin for more information.



**ORDERING INFORMATION**

**STYLE NUMBER IDENTIFICATION**

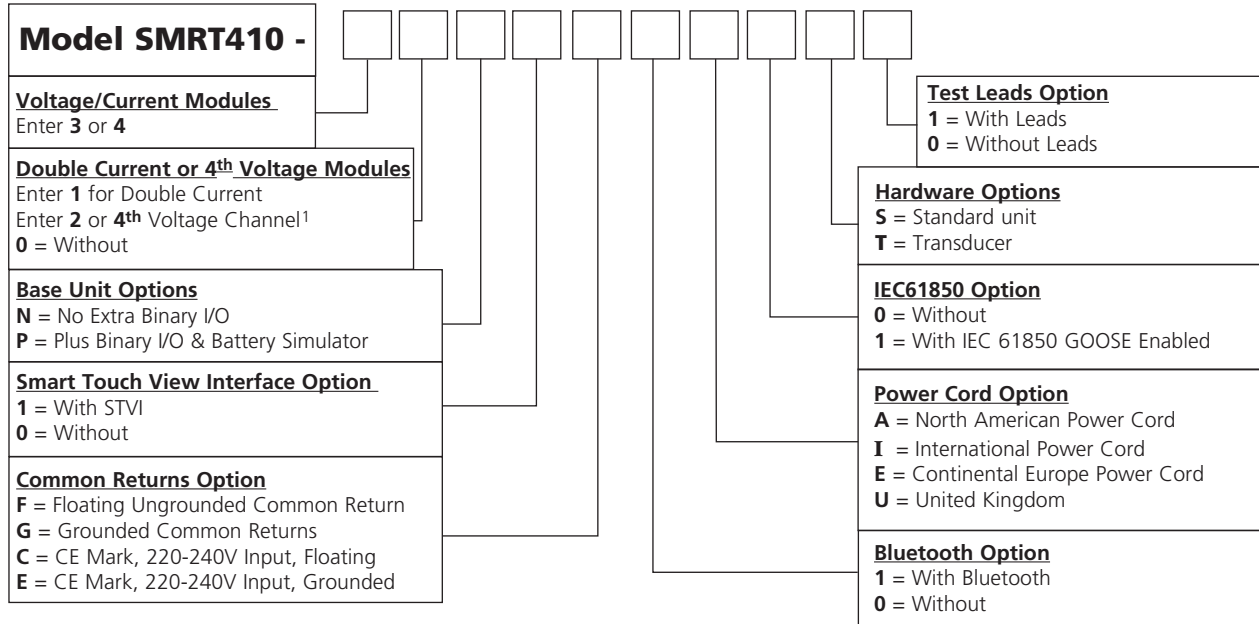

**DESCRIPTION OF SOFTWARE OPTIONS**

Included Software	Part Number
AVTS Basic with STVI Application CD	81302
<b>Software Options</b>	
AVTS Basic with IEC 61850 Megger GOOSE Configurator, and STVI Application CD	1002-103
AVTS Advanced with STVI Application CD	81570
AVTS Advanced Test with IEC 61850 Megger GOOSE Configurator, and STVI Application CD	1001-106
AVTS Professional with STVI Application CD	81571
AVTS Professional Test with IEC 61850 Megger GOOSE Configurator, and STVI Application CD	1002-102

**DESCRIPTIONS OF HARDWARE OPTIONS**

This modular system lets you select the testing capabilities you need now and expand as testing requirements change. Customize the system by adding the number of Voltage-Current amplifier (VIGEN) modules (3 or 4), with optional Double-Current (DIGEN) module. For example, start with the base unit of 3 VIGEN modules. For more demanding tests, start with 4 VIGENS, and add a DIGEN to provide 4 Voltages, 6 Currents simultaneously, with convertible voltage channels up to 10 Currents.

**Voltage/Current Module:** The SMRT410 unit can have either 3 or 4 voltage/current modules. Enter the number of desired modules 3, or 4.

**Double Current or 4<sup>th</sup> Voltage<sup>1</sup> Module:** The SMRT410 5<sup>th</sup> and last slot can be a Double Current (DIGEN) Module. Enter the number 1 for the unit to come with the DIGEN. The 4<sup>th</sup> slot can host a single Voltage Channel for those who want a 4<sup>th</sup> voltage channel in addition to 3 Voltage/Current modules. Enter the number 2 for this option.

**Base Unit Options:** The first two channels provide 1 binary input and 1 binary output each. Enter N for No extra binary I/O or battery simulator. Note the 4<sup>th</sup> voltage channel can be used as the Battery Simulator. For the user who requires the extra binary inputs, outputs and battery simulator enter P for Plus option.

**Smart Touch View Interface Option:** Enter 1 for the unit to come with the STVI, or enter the number 0 for without.

**Common Returns Option:** The floating returns option provides independent, isolated return terminals for each output channel. The grounded common returns option, the return terminals are interconnected internally and connected to chassis ground. The CE Mark C and E units are designed to operate with an input voltage of 220 to 240 Volts. The F and G units are designed to operate with an input of 100 to 240 V.

**Power Cord Option:** Customers can choose which type of power cord they want the unit to come with.

- **A Option** – NEMA 5-15 to IEC60320 C13 connectors, UL & CSA approved for countries with NEMA outlets.
- **I Option** - International color coded wires (light blue, brown and green with yellow stripe) insulation jacket stripped ready for male connector with IEC 60320 C13 connector. CE marked.
- **E Option** - CEE 7/7 "Schuko" plug to IEC 60320 C13 connector is CE marked.
- **U Option** - United Kingdom power cord with IEC 60320 C13 connector, and 13 Amp fuse. BS 1363/CE Marked.

**Bluetooth Option:** For customers who wish to have a wireless control of the SMRT unit, enter the number 1 for the unit to come with the Bluetooth option installed. Enter 0 for without.

**IEC 61850 Option:** The SMRT410 in conjunction with the Megger GOOSE Configurator (**MGC software**) can be used in the testing or commissioning of IEC 61850 compliant devices. In order for the SMRT410 to be able to subscribe as well as publish GOOSE messages, the IEC 61850 feature needs to be enabled. Enter the



number **1** for the unit to come with the IEC 61850 option enabled. Enter **0** for the unit without IEC 61850 enabled.

**Hardware Option: S** = Standard hardware. **T** = With Transducer test capability enabled.

**Test Leads Options:** Enter the number **1** for the unit to come with Test Leads. Enter **0** for the unit without Test Leads.

**Test Leads and Accessories**

All units come with a power cord (see Power Cord option), and Ethernet communication cable, and instruction manual CD. All other accessories varies depending on the options selected, see Table of Accessories.







**DESCRIPTION**

Included Standard Accessories	Part Number
Power Cord - Depending on the style number, the unit will come with one of the following,	
Line cord, North American	620000
Line cord, Continental Europe with CEE 7/7 Schuko Plug	50425
Line cord, International color coded wire	15065
Line cord, United Kingdom	90002-989
Ethernet cable for interconnection to PC, 210cm (7 ft.) long (Qty. 1 ea)	90003-684
Instruction manual CD	80989

**Table of Accessories**

Accessories are supplied with the selection of the Test Leads Option, and/or the Binary Input/Output/Battery Simulator Option, and/or the STVI Option. With the Test Leads Option the number and type

of leads varies depending on the number of channels ordered. If desired, Test Leads and Accessories can be ordered individually, see description and part numbers below.

	Optional Accessories Descriptions	STVI, or Binary I/O Bat SIM, or Test Leads Options	Three (3) Voltage Current Modules	Four (4) Voltage Current Modules	With DIGEN or VIGEN Module <sup>1</sup>	Binary I/O, Battery Simulator Option
	<b>Accessory Carry Case:</b> Use to carry power cord, Ethernet cable, Optional STVI and test leads.	Qty. 1 ea. Part No. 2001-487				
	<b>Sleeved Pair of Test Leads:</b> Keeps the test leads in pairs and from getting entangled. Sleeved Test Leads, one red, one black, 200 cm (78.7") long, 600 V, 32 Amperes CAT II.*		Qty. 3 pr. Part No. 2001-394	Qty. 4 pr. Part No. 2001-394	Qty. 2 pr. Part No. 2001-394	Qty. 3 pr. Part No. 2001-394
	<b>Cable/Spade Lug Adapter (Small):</b> Small lug fit most new relay small terminal blocks. Lug adapter, red, 4.1 mm, use with test leads up to 1000 V/ 20 Amps CAT II.		Qty. 3 ea. Part No. 684004	Qty. 14 ea. Part No. 684004	Qty. 2ea. Part No. 684004	Qty. 3 ea. Part No. 684004
	Lug adapter, black, 4.1 mm, use with test leads up to 1000 V/ 20 Amps CAT II.		Qty. 3 ea. Part Number 684005	Qty. 14 ea. Part Number 684005	Qty. 2ea. Part Number 684005	Qty. 3 ea. Part Number 684005
	<b>Jumper Lead:</b> Used to common returns together on units with floating ground returns, or parallel of current channels. Jumper lead, black, 12.5 cm (5") long, use with voltage / current outputs, 600 V, 32 Amps CAT II.		Qty. 4 ea. Part Number 2001-573	Qty. 6 ea. Part Number 2001-573		
	<b>Sleeved Combination Voltage Test Leads:</b> Keeps the test leads from getting entangled. Three common leads connect to the test set, which are interconnected down to one black common to connect to the relay under test. Sleeved Three Phase Test Leads, three red and black, 200 cm (78.7") long, 600 V, 32 Amperes CAT II.*		Qty. 1 ea. Part Number 2001-395	Qty. 1 ea. Part Number 2001-395		
	<b>Sleeved Combination Current Test Leads:</b> Keeps the test leads from getting entangled. Three pairs of leads connect to the test set, with three pairs to connect to the relay under test. Sleeved Three Phase Test Leads, three red and black, 200 cm (78.7") long, 600 V, 32 Amperes CAT II.*		Qty. 1 ea. Part Number 2001-396	Qty. 1 ea. Part Number 2001-396		

Note that the sleeved "combination" leads come with either the three, or four Voltage/Current module configurations only.

<sup>1</sup>Adding the DIGEN or VGEN module adds the extra leads and spades lugs as shown in the column.

\*600V, 32 Amperes, CAT IV available as an option.

**Descriptions of Software**

Included Software – Every unit comes with AVTS Basic and the PC version of the STVI Basic Test software packages

**AVTS Basic with STVI Application Software (PC Version)****Part No.: 81302**

AVTS Basic includes Online Vector, Online Ramp and Online Click-On-Fault controls, with the ability to import, save and execute relay specific test modules. The online tools of Vector and Ramp provide automatic pickup, or dropout tests as well as timing and multi-state dynamic tests. The Online Click-On-Fault tool is used to automatically determine the reach characteristics of single or multi-zone Distance relays using shot for single point tests, or Ramp, Pulse Ramp, or Binary Search tools along user defined search lines. Includes enhanced Relay Test Wizards for; Overcurrent, Differential, Voltage, Frequency and Distance relays.

The powerful STVI screens can be run directly from a PC providing both manual and automatic test capabilities. Intuitive menu screens and buttons are provided to quickly and easily select the desired test function. The Manual Test Screen power-up preset default values maybe automatically set from the user defined configuration screen. The user can select from a variety of test options including manual control using the cursor up down arrows or use the mouse control wheel to vary outputs. In addition a dynamic sequence test includes trip and reclose up to 9 operations. An automatic ramp, pulse ramp, or pulse ramp binary search is built in to determine pickup or drop out of relay contacts, or perform relay specific timing tests using the Timing Test Screen. A vector graph indicates the relative phase angles of all of the outputs. The user may select to have all output amplitudes metered to provide real time verification of all of the selected outputs, or have setting values displayed. The PC version of the STVI software includes the ability to bring all STVI test data (from other STVI units) into file folders for retrieval and review whenever needed. Each copy of the PC version of the STVI software is licensed for running on one PC. Additional run keys can be purchased separately.

**Additional Software Options****AVTS Advanced with STVI Application****Part No.: 81570**

AVTS Advanced includes all of the features of AVTS Basic in addition to the powerful Test Editor and test editor tools, which includes the Dynamic Control (with dynamic end-to-end test capability, and Recorder features) for developing sequential tests for virtually any function or measuring element within digital relays. In addition, it also includes SS1 File Converter for ASPEN and CAPE dynamic test files, End-to-End DFR Playback test macros and basic programming Tools for creating and editing test modules. Test files created in Advanced Test can be used with AVTS Basic.

**AVTS Professional with STVI Application****Part No.: 81571**

Professional Test includes all of the features of AVTS Advanced Test version plus the following additional specialized test tools. The DFR Waveform Viewer and Playback tools are used for viewing and analyzing IEEE C37.111 COMTRADE Standard files from digital fault recorders and microprocessor based relays. The DFR Waveform Viewer includes tools to recreate the analog and digital channels for playback into protective relays for troubleshooting or evaluation. It includes the capability to extend the pre-fault data as well as start the timer associated with the event to time relay operation. These playback test files can also be used in end-to-end tests to recreate the transient event and evaluate the protection scheme. Test files created in Professional can be used with Advanced Test and Basic. Also included is the One-Touch Test Editor Control Tool for fully automatic testing of microprocessor based relays using VB script files or Modbus communications to automatically download relay settings, and automatically test all the measuring elements within the relay based upon those settings. The Waveform Digitizer feature is also included in the Professional Test version of AVTS. It provides tools to create digital time curves for virtually any electromechanical relay time curve (that do not fit a time curve algorithm). It can even be used for digitizing scanned waveforms from a light-beam chart recorder.

**IEC 61850 Megger GOOSE Configurator Software**

The Megger GOOSE Configurator (MGC) provides easy to use tools for testing relays and substations using the IEC 61850 protocol. It is an optional software tool available with Basic, Advanced or Professional versions of AVTS Software; see **Descriptions of Software Options** above. The configurator provides relay test engineers and technicians the capability to import parameters from configuration files in the Substation Configuration Language (SCL) format, and/or capture GOOSE messages directly from the substation bus. All imported GOOSE messages will be unconfirmed messages. Only captured messages are confirmed messages due to the Capture feature of the MGC. Use the MGC Merge feature to compare imported SCL and captured GOOSE messages to verify all GOOSE messages needed to perform tests. Use them to configure the SMRT to subscribe to preselected GOOSE messages by assigning the data attributes to the appropriate binary inputs of the SMRT. Use the configurator to assign the appropriate binary outputs of the SMRT to publish GOOSE messages simulating circuit breaker status. After the appropriate assignments of binary inputs and outputs have been made, the test file can be saved for reuse. This provides both manual and automatic testing of the relay using either the STVI or AVTS software. Use standard test modules in AVTS to perform automatic tests. Use the Dynamic Control in AVTS Advanced or Professional to perform high speed trip and reclose tests, or use to perform interoperability high-speed shared I/O tests between multiple IED's. The MGC provides mappings of Boolean and Bit Strings and/or simulation of STRuct, Integer/Unsigned, Float and UTC datasets.

**Deluxe Test Leads and Accessories Kit Part No.: 1001-619**

The Test Leads and Test Lead Accessories are an option. Test leads and accessories can be ordered with the unit, or later as a kit. The Deluxe Test Leads and Accessories Kit includes sleeved pairs of leads for use with the extra binary inputs/outputs/battery simulator option, as well as the three phase sleeved combination leads for voltage and current channels. The following test leads and test lead accessories are included in the Deluxe Test Leads and Accessories Kit in quantities shown.

Description	Part No.
<b>Sleeved Combination Voltage Test Leads:</b> Keeps the test leads from getting entangled. Sleeved Three Phase Test Leads, three red and black, 200 cm (78.7") long, 600 V, 32 Amperes CAT II (Qty. 1 ea)	<b>2001-395</b>
<b>Sleeved Combination Current Test Leads:</b> Keeps the test leads from getting entangled. Sleeved Three Phase Test Leads, three red and black, 200 cm (78.7") long, 600 V, 32 Amperes CAT II (Qty. 1 ea)	<b>2001-396</b>
<b>Sleeved Pair Test Leads,</b> one red, one black, 200 cm (78.7") long, 600 V, 32 Amperes CAT II, (Qty. 5 pair)	<b>2001-394</b>
<b>Jumper lead,</b> black, 12.5 cm (5") long, use with voltage / current outputs, 600 V, 32 Amps CAT II (Qty. 4 ea.)	<b>2001-573</b>
<b>Cable/Spade Lug Adapter (Small):</b> Small lug fits most new relay small terminal blocks. Lug adapter, red, 4.1 mm, use with test leads up to 1000 V/ 20 Amps CAT II (Qty. 15 ea.)	<b>684004</b>
<b>Lug adapter, black,</b> 4.1 mm, use with test leads up to 1000 V / 20 Amps CAT II (Qty. 15 ea.)	<b>684005</b>
<b>Accessory Case,</b> black, used to carry test leads and/or STVI (Qty. 1 ea.)	<b>2001-487</b>

**Additional Accessories (Not Included in the SMRT410 Test Leads Option or Deluxe Lead Kit)**

Additional Optional Test Leads and Accessories can be ordered individually, see description and part numbers below. The following accessories and part numbers are in quantities of 1 each. Order the appropriate number required.

<b>Individual (Non-Sleeved) Test Leads:</b> Excellent for widely separated individual terminal test connections.	
	
Test Lead, red, use with voltage/current output, or binary I/O, 200 cm long (78.7") 600 V/32 Amps CAT II.	<b>620143</b>
Test Lead, black, use with voltage/current output, or binary I/O, 200 cm long (78.7") 600 V/32 Amps CAT II.	<b>620144</b>

<b>Cable/Spade Lug Adapter (Large):</b> Large spade lug fits older relay terminal blocks, or STATES® Company FTP10 or FTP14 Test paddles, ABB or General Electric test plugs with screw down terminals.	
	
Lug adapter, red, 6.2 mm, use with test leads up to 1000 V/20 Amps CAT II.	<b>684002</b>
Lug adapter, black, 6.2 mm, use with test leads up to 1000 V/20 Amps CAT II.	<b>684003</b>

Description	Part No.
<b>Alligator/Crocodile Clip:</b> Excellent for test connections to terminal screws and pins where spade lugs cannot be used.	
	
Alligator clip, red, use with test leads up to 1000 V/32 Amps CAT III.	<b>684006</b>
Alligator clip, black, use with test leads up to 1000 V/32 Amps CAT III.	<b>684007</b>

<b>Flexible Test Lead Adapter:</b> Use with rail-mounted terminals or screw clamp connections where spade lugs and crocodile/alligator clips cannot be used.	
	
Flexible test lead adapter, black, 1.8 mm male pin, use with test leads up to 1000 V/32 Amps CAT III.	<b>90001-845</b>

<b>Flexible Test Lead Adapter with Retractable Insulated Sleeve:</b> Use for connection to old style non-safety sockets with retractable protective sleeve on one end.	
	
Retractable Sleeve Test Lead, red, 50 cm (20") long, use with test leads up to 600 V, 32 Amperes CAT II.	<b>90001-843</b>
Retractable Sleeve Test Lead, black, 50 cm (20") long, use with test leads up to 600 V, 32 Amperes CAT II.	<b>90001-844</b>

<b>In-Line Fused Test Lead:</b> Use with high speed binary outputs 5 or 6 ("P" Option) to protect for accidental switching of currents higher than 1 Amp.	
	
Test lead, blue, in-line 500 mA fuse protection, 200 cm long (78.7").	<b>568026</b>

<b>In-Line Fused Test Lead:</b> Use with ("P" Option) Battery Simulator output to protect for accidental connection to substation battery.	
	
Test lead, black, in-line 3.15 A fuse protection, 200 cm long (78.7").	<b>568025</b>

<b>In-Line Resistor Test Lead:</b> Use with old solid state relays with "leaky" SCR trip gates.	
	
Test lead, red, in-line 100 k Ohm resistor, use with test leads up to 1000 V/ 32 Amps CAT III.	<b>500395</b>

Description	Part No.
<b>STATES® 10 Pole Test Paddle:</b> Use with STATES FMS Test Switch or ABB FT-1 10 pole Test Switch.	
	
Test paddle features knobs which also serve as insulated Ø 4 mm rigid socket accepting spring loaded Ø 4 mm plugs with rigged insulating sleeve, or retractable sleeve. Use with test leads up to 600 V, 32 Amperes CATII.	<b>V1TP10</b>

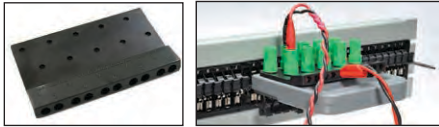
<b>STATES® 10 Pole Test Paddle Attachment:</b> Use with STATES V1TP10 Test Paddle.	
	
Test paddle attachment provides an additional 10 insulated connection points for front connection, as well as the standard top connections for test leads. Adapter can provide convenient parallel test connections of test currents to two terminals at one time. Use with test leads up to 600 V, 32 Amperes CAT II.	<b>TPA10</b>

Transit Case	
<b>Hard-Sided Transit Case:</b> Includes custom designed foam inserts for the SMRT unit and accessory case. Transit case includes retractable handle, polyurethane wheels with stainless steel bearings, double-throw latches, fold-down handles, and stainless steel hardware and padlock protection, with O-ring seal making the case water-tight, with an IP 67 rating. Tested and certified to US Department of Defense Standards for impact, vibration, and low/high storage temperatures.	
	
Rugged, hard-sided transit case (1ea).	<b>1002-787</b>

Description	Part No.
<b>Example Configurations</b>	
	
For customers in <b>North America, Central America, Japan, Philippines, South Korea, Taiwan, Thailand, Venezuela, Virgin Islands</b> , and other countries that use standard NEMA type power outlets of 100, 110, 115 or 120 volts at 50/60 Hz. could order a unit with the standard North American power cord. In this example the unit is a SMRT410 4 channel unit, with the extra binary I/O and Battery Simulator, with the STVI-1, with floating ungrounded returns, no Bluetooth, no IEC61850, with standard hardware, and with test leads.	The style number would be,  <b>SMRT410 – 40P1FOA0S1</b>
	
For customers in <b>Austria, Belgium, Finland, France, Germany, the Netherlands, Norway, Portugal, Spain, Sweden, Turkey</b> , and other countries where the CEE 7 standard connector is used could order a unit with the Continental European Power Cord with CEE 7/7 Schuko plug. In this example the unit is a 4 channel unit with double current (DIGEN) generator, with the extra binary I/O and Battery Simulator, without the STVI1, CE Marked 220-230 V Input and floating outputs, no Bluetooth, with IEC61850 enabled, with the standard hardware, and with test leads.	The style number would be,  <b>SMRT410-40P0COE1S1</b>
	
For customers in <b>United Kingdom, Ireland, Anguilla, Cyprus, Dominica, Gambia, Gibraltar, Malta, Malaysia, Malawi, St. Lucia, St. Vincent, Zambia</b> , and other countries where the UK standard connector is used could order a unit with the UK Power Cord. In this example the unit is a 4 channel unit, with the extra binary I/O and Battery Simulator, with the STVI-1, CE Marked 220-230 V input and floating commons, no Bluetooth, with IEC61850 enabled, with standard hardware, and with test leads.	The style number would be,  <b>SMRT410-40PIC0U1S1</b>
The final example is for countries that have more unique power connectors, which will require international color coded wires ready for appropriate male connectors to be installed like; <b>Australia/New Zealand, Argentina, China, India, Israel, Russia, South Africa, or Switzerland</b> . These countries are more likely to order the unit with the international color coded power cord ready for mounting the appropriate male connector. In this example the unit is a 4 channel unit, <b>with double current (DIGEN) generator</b> , with the extra binary I/O and Battery Simulator, with the STVI-1, with grounded common returns, with Bluetooth, with IEC61850 enabled, with standard hardware, and with test leads.	The style number would be,  <b>SMRT410 – 41P1G111S1</b>



---

**UK**

Archcliffe Road Dover  
CT17 9EN England  
T +44 (0) 1304 502101  
F +44 (0) 1304 207342

**UNITED STATES**

4271 Bronze Way  
Dallas TX 75237-1088 USA  
T 800 723 2861 (USA only)  
T +1 214 333 3201  
F +1 214 331 7399

**OTHER TECHNICAL SALES OFFICES**

Norristown USA, Sydney AUSTRALIA,  
Toronto CANADA, Trappes FRANCE,  
Kingdom of BAHRAIN, Mumbai INDIA,  
Johannesburg SOUTH AFRICA and  
Conjure THAILAND.

**ISO STATEMENT**

Registered to ISO 9001:2008 Cert. no. 510006.002

**SMRT410\_DS\_EN\_V10**  
[www.megger.com](http://www.megger.com)

Megger is a registered trademark

# SMRT36

## Megger Relay Test System



SMRT36 with optional  
Transducer hardware

- **Small, rugged, lightweight and powerful**
- **Operate with or without a computer**
- **Intuitive manual operation with Smart Touch View Interface**
- **High current, high power output (60 Amps/300 VA rms) per phase**
- **Convertible channels provides 6 currents**
- **Network interface provides IEC 61850 test capabilities**
- **Optional transducer test capability**
- **Fully automated testing using AVTS Software**

### DESCRIPTION

For size, weight, and features the SMRT36 is conceivably the smallest, lightest, highest output powered, complete three phase relay test system in the world today. The test system may be customized by adding the number of Voltage-Current, "VIGEN", modules needed for specific test applications. The SMRT36 has the "smart" combination of high compliance voltage and high current to test all electromechanical, solid-state and microprocessor-based overcurrent relays, including voltage controlled, voltage restraint and directional overcurrent.

The SMRT36 with three VIGEN Modules provides a complete three-phase test system for commissioning of three phase protection systems. With the voltage channels converted to currents, the same unit can provide 6-phase current. The SMRT36 VIGEN modules also provide high power in BOTH the voltage and current channels to test virtually all types of protective relays.



SMRT36 with STVI

The SMRT36 test system has the ability to be manually controlled with Megger's new Smart Touch View Interface™ (STVI). The STVI, with its large, full color, high resolution, TFT LCD touch screen allows the user to perform manual, steady-state and dynamic testing quickly and easily using the manual test screen, as well as using built-in preset test routines for most popular relays.

The STVI eliminates the need for a computer when testing virtually all types of relays. Menu screens and touch screen function buttons are provided to quickly and easily select the desired test function. Tests results can be saved to the STVI for download to a memory stick to transfer or print test reports.

For full automatic testing the SMRT36 may be controlled by Megger Advanced Visual Test Software (AVTS). AVTS is a Microsoft® Windows® XP®/Vista™/7 compatible software program designed to manage all aspects of protective relay testing using the new Megger SMRT.

### APPLICATIONS

Each current channel is rated for 30 Amps @ 200 VA continuous, up to 60 Amps @ 300 VA for short durations. It has a unique flat power curve from 4 to 30 Amps that insures maximum compliance voltage to load at all times. Three currents in parallel provide up to 180 Amps @ 900 VA for instantaneous tests. With a maximum compliance voltage of 50 Volts per phase, with just two channels in series provides 100 Volts of compliance voltage to test high impedance relays.

Each voltage channel can provide variable outputs of 0- 30/150/ 300 Volts at 150 VA of output power, and has a unique flat power curve from 30 to 150 Volts insuring maximum output power to the load at all times. With the voltage channel converted to current, a three channel unit can provide 6 currents for testing three phase current differential relays, including harmonic restraint transformer differential relays.

Using the Ethernet ports, the SMRT36 is literally a “plug-and-play” unit, where voltage and current outputs can be seamlessly synchronized with other SMRT units outputs for testing more complex test applications such as back-to-back tests, or 9 up to 12 phase current test applications.

## FEATURES AND BENEFITS

**Constant Power Output** – New higher powered Voltage-Current amplifiers. The current amplifier delivers maximum compliance voltage to the load constantly during the test, and range changing is done automatically under load. This insures better test results, and saves time by not having to turn the outputs off to change ranges. Constant power output in many cases eliminates the need to parallel or series current channels together to test high burden relays.

**High Output Current** – Provides up to 30 Amps at 200 VA per phase continuous, or up to 60 Amperes at 300 VA with a 1.5 second duty cycle. The three current amplifiers can be paralleled to provide a maximum of 180 Amperes at 900 VA, for testing all instantaneous overcurrent relays.

**New PowerV™ Voltage Amplifier High Power Output** – The SMRT provides a new higher VA power output on the voltage channel at the lower critical test voltages (from 30 to 150 Volts). Customers who want to test a panel of relays at one time find it impossible using lower VA rated voltage.

**Convertible Voltage Channels** – With a 3 channel SMRT36 unit, convertible channels in conjunction with the three main current channels, provides 6 currents for testing three phase current differential relays. With all six currents in parallel the unit can provide a maximum single phase output of 225 Amperes for short durations.

**High resolution and accuracy** – Metered outputs provides extremely high accuracy needed for testing a wide variety of devices. With metered values, what you see is what you get.

**Steady-State and Dynamic testing capability** – The SMRT36 provides, either through manual control or computer control, both steady-state and dynamic testing of protective relays. This includes programmable waveforms with dc offset and harmonics.

**Output current and voltage sine waves are generated digitally** – Outputs do not vary with sudden changes in input voltage or frequency, which increases test accuracy and reduces testing time.

**Modular design** – Output modules plug-in and out easily for system re-configuration and maintenance.

**Built-in Transducer Testing Capability** – The SMRT36P incorporates high accuracy amplifiers, an optional transducer DC input and test algorithms to test transducers easily and effectively.

**Digital binary inputs and outputs** – The programmable binary inputs, and programmable outputs provide timing and logic operations in real-time with the output voltage and currents. Binary Inputs can be programmed, using Boolean logic, for more complex power system simulations. This provides a low cost, closed loop, power system simulator.

**Circuit breaker simulator** – Binary outputs provide programmable normally closed and normally open contacts to simulate circuit breaker operation for testing reclosing relays. Sequence of operation, timing, and lockout are easily tested.

**Performs transient tests** – Perform acceptance or troubleshooting tests by replaying digitally recorded faults or EMTP/ATP simulations in the IEEE- C37.111, COMTRADE Standard format.

**Perform End-to-End tests** – Using AVTS software and a portable GPS satellite receiver, the SMRT performs satellite-synchronized end-to-end dynamic multi-state or playback transient COMTRADE files either for commissioning or troubleshooting tests.

**Wide-ranging output frequency** – The output frequency of the current and voltage channels can be set for any frequency from dc to 1 kHz. Popular test frequencies such as 16.66, 25, 33, 50, 60, 100, 120, 125, 150, 180, 250, 300 and 400 Hz are easily set and controlled. Multi-purpose test system saves time and money.

**USB 2.0 interface port** – The USB port provides a PC interface for automated control of the SMRT unit. Also provides secure isolation when testing IEC 61850 devices (for customers who require secure isolation from their IEC 61850 substation bus).

**Three Ethernet ports** – PC/OUT Ethernet Port is the primary PC connection port. The IN/IEC61850 Ethernet Port provides interface to multiple SMRT units, and may be used to connect to the IEC 61850 substation bus. The OUT Ethernet Port is primarily used to interconnect multiple SMRT units together for synchronous multi-unit operation. The STVI PoE (Power over Ethernet) port and is used to connect to the STVI.

**Bluetooth** – Optional Bluetooth provides more flexibility. A wireless interface between the PC and SMRT, in conjunction with the SMRT IEC 61850 Ethernet port, provides the isolation required for a secure substation access interface between the SMRT and the IEC 61850 substation network.

**Universal input voltage** – Operation from 90 to 264 Vac, 50/60 Hz, the SMRT can use virtually any standard source in the world.

**Immediate error indication** – Audible and visual alarms indicate when amplitude or waveforms of the outputs are in error.

**Optional Transducer Testing Capability** – This optional hardware feature (see Ordering Information) provides transducer DC Inputs to test transducers easily and effectively. The STVI software is designed to automatically recognize the Transducer DC Inputs, and thus provide the Transducer Test Screen when selected. AVTS software comes standard with Transducer Test Modules, which will provide automatic transducer test capability in conjunction with the optional hardware.

SMRT36 RELAY TESTER

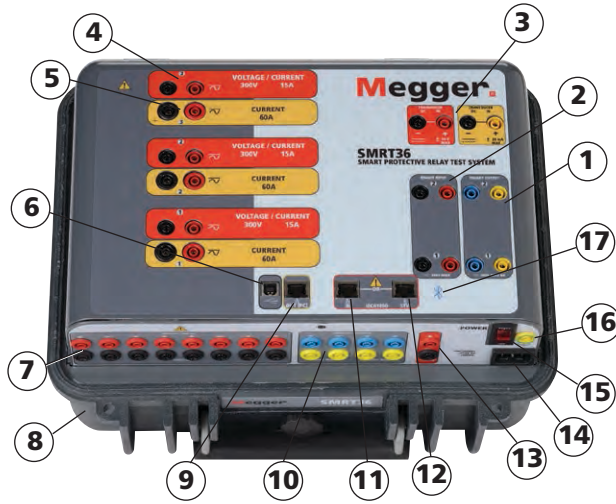

1. **Binary Outputs 1 and 2:** Rated for 300 V at 8 Amps.
2. **Binary Inputs 1 and 2:** Rated 5 to 300 V AC/DC.
3. **Transducer Input:** (Optional) DC voltage and DC milliamp input terminals.
4. **Voltage Outputs:** Up to 3 channels 300 V at 150 VA, convertible to currents 15 A at 120 VA per phase.
5. **Current Outputs:** Up to 3 channels 60 Amps at 300 VA per phase. Up 180 Amps at 900 VA single phase.
6. **USB 2.0 Interface:** Communication and control port.
7. **Additional Binary Inputs:** Provides 8 additional monitor circuits.
8. **Rugged Case:** Fiberglass reinforced plastic.
9. **PC/OUT:** Ethernet Port is the primary PC connection port. Ethernet Port used to chain multiple SMRT units together for synchronous multi-unit operation.
10. **Additional Binary Outputs:** Adds 4 outputs. Binary Outputs 3 and 4 are rated for 300 V AC/DC, 8 amperes. Binary Outputs 5 and 6 are high speed and have an AC/DC voltage rating of 400 volts peak, 1 ampere.
11. **IN/61850:** This port may also be used for connecting to the IEC 61850 substation bus for testing IEC 61850 devices.
12. **STVI:** Ethernet Port is a PoE (Power over Ethernet) port and is used to connect to the STVI for manual control.
13. **Battery Simulator:** Variable 5 to 250 Volts DC output at 100 Watts (4 amperes maximum).
14. **Incoming Power/Line Cord Socket:** 100 to 240 V, 50/60 Hz.
15. **POWER ON/OFF Switch:** Illuminates when power is on.
16. **Protective Earth Ground Jack.**
17. **Bluetooth:** Bluetooth® provides wireless control.

APPLICATIONS SELECTION GUIDE

Protective Relays by IEEE Device #		SMRT36 Single Channel	SMRT36 Two Channels	SMRT36 Three Channels
2	Time Delay	■	■	■
21	Distance Single Phase	■	■	■
21	Distance Three Phase Open Delta		■	■
21	Distance Three Phase wye			■
24	Volts/Hz	■	■	■
25	Synchronizing		■	■
27/59	Under/Over Voltage	■	■	■
32	Directional Power Single Phase	■	■	■
32	Directional Power Three Phase (Open Delta)		■	■
37/76	DC Under/Over Voltage/Current	■	■	■
40	Loss of Field	■	■	■
46	Phase Balance Current	■	■	■
46N	Negative Sequence Overcurrent	■	■	■
47	Phase Sequence Voltage (Open Delta)		■	■
50	Instantaneous Overcurrent	Up to 75 Amps	Up to 150 Amps	Up to 225 Amps
51	Time Delay Overcurrent	Up to 35 Amps	Up to 70 Amps	Up to 105 Amps
55	Power Factor	■	■	■
60	Voltage/Current Balance (Open Delta)	Single Phase	■	■
67	Directional Overcurrent	■	■	■
67N	Ground Directional Overcurrent	■	■	■
78	Out of Step	■	■	■
79	Reclosing	■	■	■
81	Frequency	■	■	■
85	Carrier or Pilot Wire	■	■	■
87	Differential	■	■	■
91	Voltage Directional (Open Delta)		■	■
92	Voltage and Power Directional (Open Delta)		■	■
94	Tripping	■	■	■



**SPECIFICATIONS<sup>1</sup>**

**Input Power**

The input voltage rating varies depending upon the style number. Universal units, the input voltage may be from 100 to 240 VAC, ± 10%, 50/60 Hertz. CE Marked units, the input voltage may be from 220 to 240 VAC, ± 10%, 50/60 Hertz. Total maximum output power will be limited for CE marked units. Input current required varies with the number of output modules in use, load, and input voltage value. With three VIGENS, the maximum input power is 1800VA.

**Outputs**

All outputs are independent from sudden changes in mains voltage and frequency, and are regulated so changes in load impedance do not affect the output. All amplifier outputs are isolated or floating. The SMRT units can be ordered with the amplifier common returns tied to chassis ground as an option.

**Output Current Sources**

The SMRT36 with three VIGEN modules can provide up to six current sources; three high current/high power, and three convertible channels providing lower current/high power. The per channel output current and power ratings are specified in AC rms values and peak power ratings.

Output Current	Power	Max V/Duty Cycle
1 Ampere	15 VA	15.0 Vrms Continuous
4 Amperes	200 VA (282 peak)	50.0 Vrms Continuous
15 Amperes	200 VA (282 peak)	13.4 Vrms Continuous
30 Amperes	200 VA (282 peak)	6.67 Vrms Continuous
60 Amperes	300 VA (424 peak)	5.00 Vrms 90 Cycles
DC	200 Watts	

**With three currents in parallel:**

Output Current	Power	Max V/Duty Cycle
12 Amperes	600 VA (848 peak)	50.0 Vrms Continuous
45 Amperes	600 VA (848 peak)	13.4 Vrms Continuous
90 Amperes	600 VA (848 peak)	6.67 Vrms Continuous
180 Amperes	900 VA (1272 peak)	5.00 Vrms 90 Cycles

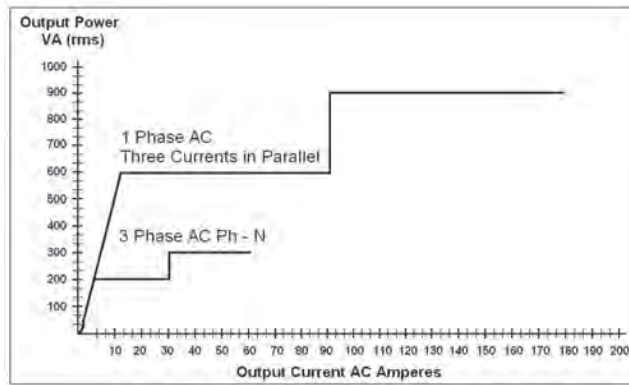

Current Amplifier Output Power Curve

**With two currents in series:**

The compliance voltage doubles to provide 4.0 Amperes at 100 Volts rms.

**Current Amplifier - Extended Power Range**

The SMRT current amplifier provides a unique flat power curve from 4 to 30 Amperes per phase to permit testing of electromechanical high impedance relays, and other high burden applications, with an extended operating range up to 60 Amperes at 300 VA rms.

**AC Voltage Output**

Outputs are rated with the following Ranges:

Output Volts	Power	Max I
30 Volts	150 VA	5 Amps
150 Volts	150 VA	Variable <sup>2</sup>
300 Volts	150 VA	0.5 Amps
DC	150 Watts	

**Duty Cycle:** Continuous

**With two voltages in series**

The output voltage and power doubles to provide 600 volts at 300 VA.

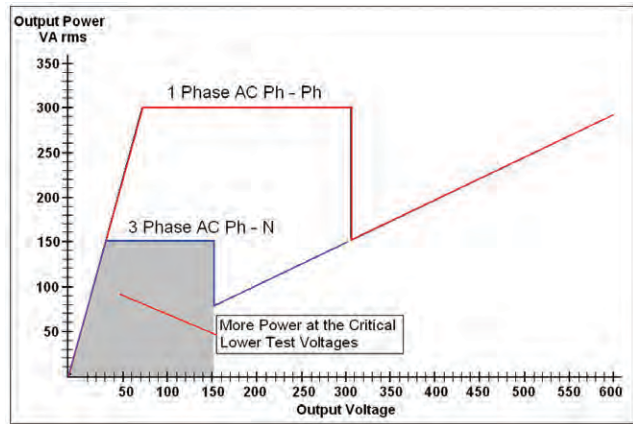

"PowerV" Voltage Amplifier Output Power Curves

**"PowerV™" Voltage Amplifier - Extended Power Range**

The SMRT voltage amplifier provides a flat power curve from 30 to 150 Volts in the 150V range to permit testing of high current applications such as panel testing.

**Voltage Amplifier in Current Mode:**

The voltage amplifier is convertible to a current source with the following output capability. Output power ratings are specified in rms values and peak power ratings.

Output Current	Power	Max V	Duty Cycle
5 Amperes	150 VA (212 peak)	30.0 Vrms	Continuous
15 Amperes	120 VA	8.0 Vrms	90 Cycles

**Phase Angle**

**Ranges:** 0.00 to 359.99 degrees, Counter Clock Wise, or Clock Wise rotation, or 0.00 to ±180.00 degrees

**Accuracy:** ±0.02° typical, ±0.25° max at 50/60 Hz

<sup>1</sup> Megger reserves the right to change product specifications at any time.

<sup>2</sup> PowerV™ voltage amplifier output current varies depending on the voltage setting on the 150 Volt range, see curve.

**Frequency**

The output modules provide a variable frequency output with the following ranges and accuracy.

**Ranges**

DC

0.001 to 1000.000 Hz

Output amplifiers can provide transient signals with a range of DC to 10 kHz for transient playback using COMTRADE files.

**Resolution\*:** .0001/.001 Hz

**Frequency Accuracy:**

2.5 ppm typical

25 ppm 0° to 50° C, at 50/60 Hz Maximum

**Total Harmonic Distortion**

Less than 0.1% typical, 2% maximum at 50/60 Hz

**Timer**

The Timer-Monitor Input is designed to monitor and time-tag inputs, like a sequence of events recorder. In addition, the binary input controls enable the user to perform logic AND/OR functions, and conditionally control the binary output relay to simulate circuit breaker, trip, reclose and carrier control operation in real-time. The Timer function displays in Seconds or Cycles, with the following range and resolution:

**Seconds:** 0.0001 to 99999.9

**(Auto Ranging)**

**Cycles:** 0.01 to 99999.9

**(Auto Ranging)**

**Accuracy:**  $\pm 0.001\%$  of reading, typical.  $\pm 2$  least significant digit,  $\pm 0.005\%$  of reading from 0 to 50° C maximum

**Binary Input – Start/Stop/Monitor Gate**

To monitor operation of relay contacts or trip SCR, continuity light is provided for the input gate. Upon sensing continuity the lamp will glow. In addition to serving as wet/dry contacts the Binary Inputs may be programmed to trigger binary output sequence(s).

**Input Rating:** up to 300 V AC/DC

**Binary Output Relays**

SMRT36 has independent, galvanically isolated, output relay contacts to accurately simulate relay or power system inputs to completely test relays removed from the power system. The binary output simulates normally open / normally closed contacts for testing breaker failure schemes. The binary output can be configured to change state based on binary input logic.

**High Current Output Relays:** The first two VIGEN Modules have 1 each and the P option add 2 more.

**AC Rating:** 400 V max., I<sub>max</sub>: 8 amps, 2000 VA max.

**DC Rating:** 300 V max., I<sub>max</sub>: 8 amps, 80 W

**Response Time:** <10ms

**High Speed Output Relays:** SMRT36 P Option adds 2

**AC/DC Rating:** 400 V peak, I<sub>max</sub>: 1 amp

**Response Time:** <1ms typical

**Battery Simulator**

The SMRT36 with the P (Plus) option includes a battery simulator with a variable DC output voltage ranging from 5 to 250 Volts at 100 Watts, 4 Amps max, providing capability to power up relays with redundant power supplies. Voltage output is controlled via the Smart Touch-View Interface, or through AVTS software. The SMRT36 with the N option does not include a battery simulator.

**Waveform Generation**

Each output channel can generate a variety of output waveforms such as: DC; sine wave; sine wave with percent harmonics at various phase angles; half waves; square waves with variable duty cycles; exponential decays; periodic transient waveforms from digital fault recorders, relays with waveform recording capability or EMTP/ATP programs, which conform to the IEEE C37.111 COMTRADE standard format.

**Metering**

Measured output quantities such as AC Amperes, AC Volts, DC Volts or DC Amperes, and Time may be simultaneously displayed on the large, color TFT LCD touch screen. The AC and DC outputs display the approximate voltage/current output prior to initiation of the outputs. All accuracies stated are from 10 to 100% of the range at 50/60Hz.

**AC Voltage Amplitude**

**Accuracy:**  $\pm 0.05\%$  reading + 0.02 % range typical,  $\pm 0.15\%$  reading + 0.05 % range maximum

**Resolution:** .01

**Measurements:** AC RMS

**Ranges:** 30, 150, 300V

**AC Current Amplitude**

**Accuracy:**  $\pm 0.05\%$  reading + 0.02 % range typical,  $\pm 0.15\%$  reading + 0.05 % range maximum

**Resolution:** .001/.01

**Measurements:** AC RMS

**Ranges:** 30, 60A

**DC Voltage Amplitude**

**Accuracy:** 0.1% range typical, 0.25% range maximum

**Resolution:** .01

**Measurements:** RMS

**Ranges:** 30, 150, 300V

**DC Current Amplitude**

**Accuracy:**  $\pm 0.05\%$  reading + 0.02 % range typical,  $\pm 0.15\%$  reading + 0.05 % range maximum

**Resolution:** .001/.01

**Measurements:** RMS

**Ranges:** 30A

**Convertible Source in AC Current Mode**

**Accuracy:**  $\pm 0.05\%$  reading +  $0.02\%$  range typical,  
 $\pm 0.15\%$  reading +  $0.05\%$  range or  $\pm 12.5$  mA whichever is greater  
**Resolution:** .001  
**Measurements:** AC RMS  
**Range:** 5, 15A

**The DC IN input terminals**

**Range:** 0 to  $\pm 10$  V DC  
 0 to  $\pm 20$  mA DC  
**Accuracy:**  $\pm 0.02\%$  Typical  
 $\pm 0.05\%$  Max FS  
**Measurements:** Average

**DC IN Inputs (Optional Transducer Feature)****DC IN Volts**

**Range:** 0 to  $\pm 10$  V DC  
**Accuracy:**  $\pm 0.001\%$  reading +  $0.005\%$  range Typical  
 $\pm 0.003\%$  reading +  $0.02\%$  range Max  
**Resolution:** .001  
**Measurements:** Average

**DC IN Amperes**

**Range:** 0 to  $\pm 1$  mA DC  
 4 to  $\pm 20$  mA DC  
**Accuracy:**  $\pm 0.001\%$  reading +  $0.005\%$  range Typical  
 $\pm 0.003\%$  reading +  $0.02\%$  range Max  
**Resolution:** .001  
**Measurements:** Average

**Environmental**

**Operating Temperature:** 32 to 122° F (0 to 50° C)  
**Storage Temperature:** -40 to 158° F (-40 to 70° C)  
**Relative Humidity:** 5 - 90% RH, Non-condensing

**Unit Enclosure**

The SMRT unit comes housed in a rugged, virtually indestructible, lightweight and ergonomic enclosure. It features a large oversized rubber cushioned handle, and removable lid for use in tight spaces.

**Dimensions**

**With the lid on:**  
 14.2 W x 7.6 H x 12.0 D in.  
 (360 W x 194 H x 305 D mm)

**With the lid off:**  
 14.2 W x 7.2 H x 12.0 D in.  
 (360 W x 180 H x 305 D mm)

**IEC Enclosure Rating:** IP30

**Weight**

**With the transit lid on:** 27.9 lb. (12.55 kg)  
**With the transit lid off:** 25.8 lb. (11.6 kg)

**Conformance Standards**

**Safety:** EN 61010-1  
**Shock:** MIL-PRF-28800F (30 g/11 ms half-sine)  
 IEC 60068-2-27 (15 g/11 ms half-sine)  
**Vibration:** MIL-PRF-28800F (10-500 Hz, 2.05 g rms)  
 IEC 60068-2-6 (10-150 Hz, 2 g)  
**Transit Drop:** MIL-PRF-28800F (10 drops, 46 cm), ISTA 1A

**Electromagnetic Compatibility**

**Emissions:** EN 61326-2-1, EN 61000-3-2/3,  
 FCC Subpart B of Part 15 Class A  
**Immunity:** EN 61000-4-2/3/4/5/6/8/11

**Protection**

Voltage outputs are protected from short circuits and thermally protected against prolonged overloads. Current outputs are protected against open circuits and thermally protected against prolonged overloads.

**Communication Interfaces**

Ethernet (2)  
 USB 2.0  
 Bluetooth (optional)

**SOFTWARE****AVTS – STVI Basic**

Every unit comes with **AVTS Basic** software and the PC version of the **STVI Basic** software packages. AVTS Basic version includes Online Vector control (for single and multi-state timing tests), Online Ramp control (for automatic ramping of voltage, current, phase angles or frequency) and Online Click-On-Fault (for dynamic tests of impedance relays). Test results may be exported directly to Microsoft Word. AVTS software includes a database for saving test results, which can also provide the necessary information needed for system reliability audits. See **AVTS** bulletin for more information.

The PC version of the STVI software includes the ability to bring all STVI test data (from other STVI units) into file folders for retrieval, review and printing whenever needed. See **STVI** bulletin for more information.

**AVTS Advanced**

The AVTS Advanced version includes all the feature in AVTS Basic plus the powerful Test Editor, Dynamic Control (includes dynamic end-to-end testing capability, and waveform recording capability), ASPEN OneLiner™ or Electrocon CAPE™ SS1 File Converter for dynamic testing, and easy to use programming Tools for creating and editing test modules. See **AVTS** bulletin for more information.

**AVTS Professional**

The AVTS Professional version includes all of the features of the Basic and Advanced versions plus some other powerful test tools and features. It includes the DFR Waveform Viewer, One-Touch™ Test for fully automatic tests, Modbus communication test capability, and Waveform Digitizer to digitize scanned waveforms of electromechanical over current time curves. See **AVTS** bulletin for more information.

**IEC 61850 GOOSE**

The SMRT with the GOOSE enabled, in conjunction with the Megger GOOSE Configurator (MGC) software, can be used in the testing or commissioning of IEC 61850 compliant devices. See **AVTS** bulletin for more information.

**ORDERING INFORMATION**

**STYLE NUMBER IDENTIFICATION**

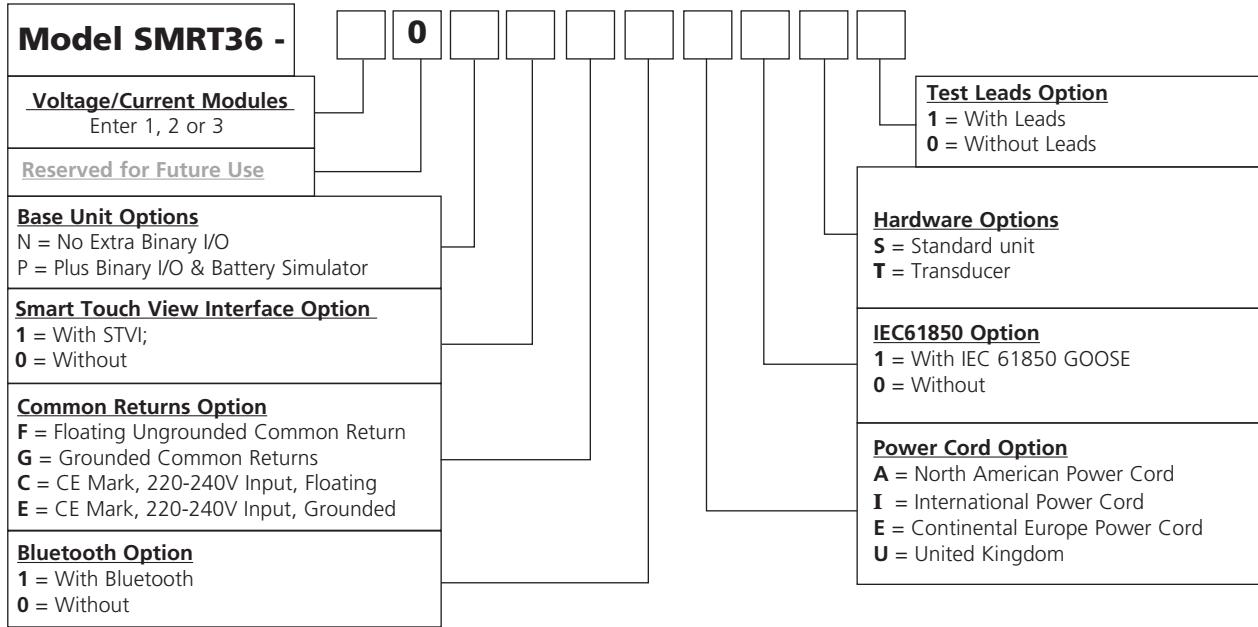

**DESCRIPTION OF SOFTWARE OPTIONS**

Included Software	Part Number
AVTS Basic with STVI Application CD	81302
<b>Software Options</b>	
AVTS Basic with IEC 61850 Megger GOOSE Configurator, and STVI Application CD	1002-103
AVTS Advanced with STVI Application CD	81570
AVTS Advanced Test with IEC 61850 Megger GOOSE Configurator, and STVI Application CD	1001-106
AVTS Professional with STVI Application CD	81571
AVTS Professional Test with IEC 61850 Megger GOOSE Configurator, and STVI Application CD	1002-102

**DESCRIPTIONS OF HARDWARE OPTIONS**

**Voltage/Current Module:** The SMRT36 unit can have up to a total of 3 voltage/current modules. Enter the number of desired Voltage / Current modules **1, 2 or 3**.

**Future:** **0**, Reserved for future use.

**Base Unit Options:** The first two channels provide **1** binary input and **1** binary output each. Enter **N** for No extra binary I/O or battery simulator. For the user who requires the extra binary inputs, outputs and/or the battery simulator enter **P** for Plus option.

**Smart Touch View Interface Option:** Enter the number **1** for the unit to come with the STVI, or enter the number **0** for without.

**Common Returns Option:** The floating returns option provides independent, isolated return terminals for each output channel. The grounded common returns option, the return terminals are interconnected internally and connected to chassis ground. The CE Mark **C** and **E** units are designed to operate with an input voltage of 220 to 240 Volts. The **F** and **G** units are designed to operate with an input of 100 to 240 V.

**Bluetooth Option:** For customers, who wish to have a wireless control of the SMRT unit, enter the number **1** for the unit to come with the Bluetooth option, or enter **0** for without.

**Power Cord Option:** Customers can choose which type of power cord they want the unit to come with.

- **A Option** – NEMA 5-15 to IEC60320 C13 connectors, UL & CSA approved for countries with NEMA outlets.
- **I Option** - International color coded wires (light blue, brown and green with yellow stripe) insulation jacket stripped ready for male connector with IEC 60320 C13 connector. CE marked.
- **E Option** - CEE 7/7 “Schuko” plug to IEC 60320 C13 connector is CE marked.
- **U Option** - United Kingdom power cord with IEC 60320 C13 connector, and 13 Amp fuse. CE Marked.

**Bluetooth Option:** For customers who wish to have a wireless control of the SMRT unit, enter the number **1** for the unit to come with the Bluetooth option installed. Enter **0** for without.

**IEC 61850 Option:** The SMRT36 in conjunction with the Megger GOOSE Configurator (MGC) software can be used in the testing or commissioning of IEC 61850 compliant devices. In order for the SMRT36 to be able to subscribe as well as publish GOOSE messages, the IEC 61850 feature needs to be enabled. Enter the number **1** for the unit to come with the IEC 61850 option enabled. Enter **0** for the unit without IEC 61850 enabled.



**Hardware Options:** **S** for Standard hardware. **T** for Transducer enabled.

**Test Leads Option:** Enter the number **1** for the unit to come with Test Leads. Enter **0** for the unit without Test Leads.

**Test Leads and Accessories**

All units come with a power cord (see Power Cord option), and Ethernet communication cable, and instruction manual CD. All other accessories varies depending on the options selected, see Table of Accessories.







**DESCRIPTION**

Included Standard Accessories	Part Number
Power Cord - Depending on the style number, the unit will come with one of the following,	
Line cord, North American	620000
Line cord, Continental Europe with CEE 7/7 Schuko Plug	50425
Line cord, International color coded wire	15065
Line cord, United Kingdom	90002-989
Ethernet cable for interconnection to PC, 210cm (7 ft.) long (Qty. 1 ea)	90003-684
Instruction manual CD	80989

**Table of Accessories**

Accessories are supplied with the selection of the Test Leads Option, and/or the Binary Input / Output / Battery Simulator Option, and/or the STVI Option. With the Test Leads Option the number and type

of leads varies depending on the number of channels ordered. If desired, Test Leads and Accessories can be ordered individually, see description and part numbers below.

	Optional Accessories Descriptions	STVI, or Binary I/O Bat SIM, or Test Leads Options	One (1) Voltage Current Module	Two (2) Voltage Current Modules	Three (3) Voltage Current Modules	Binary I/O, Battery Simulator Option
	<b>Accessory Carry Case:</b> Use to carry power cord, Ethernet cable, Optional STVI and test leads.	Qty. 1 ea. Part No. 2001-487				
	<b>Sleeved Pair of Test Leads:</b> Keeps the test leads in pairs and from getting entangled. Sleeved Test Leads, one red, one black, 200 cm (78.7") long, 600 V, 32 Amperes CAT II.		Qty. 3 pr. Part No. 2001-394	Qty. 6 pr. Part No. 2001-394	Qty. 2 pr. Part No. 2001-394	Qty. 3 pr. Part No. 2001-394
	<b>Cable/Spade Lug Adapter (Small):</b> Small lug fit most new relay small terminal blocks. Lug adapter, red, 4.1 mm, use with test leads up to 1000 V/ 20 Amps CAT II.		Qty. 3 ea. Part No. 684004	Qty. 6 ea. Part No. 684004	Qty. 12ea. Part No. 684004	Qty. 3 ea. Part No. 684004
	Lug adapter, black, 4.1 mm, use with test leads up to 1000 V/ 20 Amps CAT II.		Qty. 3 ea. Part Number 684005	Qty. 6 ea. Part Number 684005	Qty. 12ea. Part Number 684005	Qty. 3 ea. Part Number 684005
	<b>Jumper Lead:</b> Used to common returns together on units with floating ground returns, or parallel of current channels. Jumper lead, black, 12.5 cm (5") long, use with voltage / current outputs, 600 V, 32 Amps CAT II.			Qty. 2 ea. Part Number 2001-573	Qty. 4 ea. Part Number 2001-573	
	Sleeved Combination Voltage Test Leads: Keeps the test leads from getting entangled. Three common leads connect to the test set, which are interconnected down to one black common to connect to the relay under test. Sleeved Three Phase Test Leads, three red and black, 200 cm (78.7") long, 600 V, 32 Amperes CAT II.				Qty. 1 ea. Part Number 2001-395	
	Sleeved Combination Current Test Leads: Keeps the test leads from getting entangled. Three pairs of leads connect to the test set, with three pairs to connect to the relay under test. Sleeved Three Phase Test Leads, three red and black, 200 cm (78.7") long, 600 V, 32 Amperes CAT II.				Qty. 1 ea. Part Number 2001-396	

Note that the sleeved combination leads only come with the three module configuration.

### Descriptions of Software

Included Software – Every unit comes with AVTS Basic and the PC version of the STVI Basic Test software packages

#### AVTS Basic with STVI Application Software (PC Version)

Part No.: 81302

AVTS Basic includes Online Vector, Online Ramp and Online Click-On-Fault controls, with the ability to import, save and execute relay specific test modules. The online tools of Vector and Ramp provide automatic pickup, or dropout tests as well as timing and multi-state dynamic tests. The Online Click-On-Fault tool is used to automatically determine the reach characteristics of single or multi-zone Distance relays using shot for single point tests, or Ramp, Pulse Ramp, or Binary Search tools along user defined search lines. Includes enhanced Relay Test Wizards for; Overcurrent, Differential, Voltage, Frequency and Distance relays.

The powerful STVI screens can be run directly from a PC providing both manual and automatic test capabilities. Intuitive menu screens and buttons are provided to quickly and easily select the desired test function. The Manual Test Screen power-up preset default values maybe automatically set from the user defined configuration screen. The user can select from a variety of test options including manual control using the cursor up down arrows or use the mouse control wheel to vary outputs. In addition a dynamic sequence test includes trip and reclose up to 9 operations. An automatic ramp, pulse ramp, or pulse ramp binary search is built in to determine pickup or drop out of relay contacts, or perform relay specific timing tests using the Timing Test Screen. A vector graph indicates the relative phase angles of all of the outputs. The user may select to have all output amplitudes metered to provide real time verification of all of the selected outputs, or have setting values displayed. The PC version of the STVI software includes the ability to bring all STVI test data (from other STVI units) into file folders for retrieval and review whenever needed. Each copy of the PC version of the STVI software is licensed for running on one PC. Additional run keys can be purchased seperately.

### Additional Software Options

#### AVTS Advanced with STVI Application

Part No.: 81570

AVTS Advanced includes all of the features of AVTS Basic in addition to the powerful Test Editor and test editor tools, which includes the Dynamic Control (with dynamic end-to-end test capability, and Recorder features) for developing sequential tests for virtually any function or measuring element within digital relays. In addition, it also includes SS1 File Converter for ASPEN and CAPE dynamic test files, End-to-End DFR Playback test macros and basic programming Tools for creating and editing test modules. Test files created in Advanced Test can be used with AVTS Basic.

#### AVTS Professional with STVI Application

Part No.: 81571

Professional Test includes all of the features of AVTS Advanced Test version plus the following additional specialized test tools. The DFR Waveform Viewer and Playback tools are used for viewing and analyzing IEEE C37.111 COMTRADE Standard files from digital fault recorders and microprocessor based relays. The DFR Waveform Viewer includes tools to recreate the analog and digital channels for playback into protective relays for troubleshooting or evaluation. It includes the capability to extend the prefault data as well as start the timer associated with the event to time relay operation. These playback test files can also be used in end-to-end tests to recreate the transient event and evaluate the protection scheme. Test files created in Professional can be used with Advanced Test and Basic. Also included is the One-Touch Test Editor Control Tool for fully automatic testing of microprocessor based relays using VB script files or Modbus communications to automatically download relay settings, and automatically test all the measuring elements within the relay based upon those settings. The Waveform Digitizer feature is also included in the Professional Test version of AVTS. It provides tools to create digital time curves for virtually any electromechanical relay time curve (that do not fit a time curve algorithm). It can even be used for digitizing scanned waveforms from a light-beam chart recorder.

### IEC 61850 Megger GOOSE Configurator Software

The Megger GOOSE Configurator (MGC) provides easy to use tools for testing relays and substations using the IEC 61850 protocol. It is an optional software tool available with Basic, Advanced or Professional versions of AVTS Software; see **Descriptions of Software Options** above. The configurator provides relay test engineers and technicians the capability to import parameters from configuration files in the Substation Configuration Language (SCL) format, and/or capture GOOSE messages directly from the substation bus. All imported GOOSE messages will be unconfirmed messages. Only captured messages are confirmed messages due to the Capture feature of the MGC. Use the MGC Merge feature to compare imported SCL and captured GOOSE messages to verify all GOOSE messages needed to perform tests. Use them to configure the SMRT to subscribe to preselected GOOSE messages by assigning the data attributes to the appropriate binary inputs of the SMRT. Use the configurator to assign the appropriate binary outputs of the SMRT to publish GOOSE messages simulating circuit breaker status. After the appropriate assignments of binary inputs and outputs have been made, the test file can be saved for reuse. This provides both manual and automatic testing of the relay using either the STVI or AVTS software. Use standard test modules in AVTS to perform automatic tests. Use the Dynamic Control in AVTS Advanced or Professional to perform high speed trip and reclose tests, or use to perform interoperability high-speed shared I/O tests between multiple IED's. The MGC provides mappings of Boolean and Bit Strings and/or simulation of STRuct, Integer/Unsigned, Float and UTC datasets.

Deluxe Test Leads and Accessories Kit Part No.: 1001-619

The Test Leads and Test Lead Accessories are an option. Test leads and accessories can be ordered with the unit, or later as a kit. The Deluxe Test Leads and Accessories Kit includes sleeved pairs of leads for use with the extra binary inputs/outputs/battery simulator option, as well as the three phase sleeved combination leads for voltage and current channels. The following test leads and test lead accessories are included in the Deluxe Test Leads and Accessories Kit in quantities shown.

Description	Part No.
<b>Sleeved Combination Voltage Test Leads:</b> Keeps the test leads from getting entangled. Sleeved Three Phase Test Leads, three red and black, 200 cm (78.7") long, 600 V, 32 Amperes CAT II (Qty. 1 ea)	2001-395
<b>Sleeved Combination Current Test Leads:</b> Keeps the test leads from getting entangled. Sleeved Three Phase Test Leads, three red and black, 200 cm (78.7") long, 600 V, 32 Amperes CAT II (Qty. 1 ea)	2001-396
<b>Sleeved Pair Test Leads,</b> one red, one black, 200 cm (78.7") long, 600 V, 32 Amperes CAT II, (Qty. 5 pair)	2001-394
<b>Jumper lead,</b> black, 12.5 cm (5") long, use with voltage / current outputs, 600 V, 32 Amps CAT II (Qty. 4 ea.)	2001-573
<b>Cable/Spade Lug Adapter (Small):</b> Small lug fits most new relay small terminal blocks. Lug adapter, red, 4.1 mm, use with test leads up to 1000 V / 20 Amps CAT II (Qty. 15 ea.)	684004
<b>Lug adapter, black,</b> 4.1 mm, use with test leads up to 1000 V / 20 Amps CAT II (Qty. 15 ea.)	684005
<b>Accessory Case,</b> black, used to carry test leads and/or STVI (Qty. 1 ea.)	2001-487

**Additional Accessories (Not Included in the SMRT36 Test Leads Option or Deluxe Lead Kit)**  
Additional Optional Test Leads and Accessories can be ordered individually, see description and part numbers below. The following accessories and part numbers are in quantities of 1 each. Order the appropriate number required.

<b>Individual (Non-Sleeved) Test Leads:</b> Excellent for widely separated individual terminal test connections.	
	
Test Lead, red, use with voltage/current output, or binary I/O, 200 cm long (78.7") 600 V/32 Amps CAT II.	620143
Test Lead, black, use with voltage/current output, or binary I/O, 200 cm long (78.7") 600 V/32 Amps CAT II.	620144

<b>Cable/Spade Lug Adapter (Large):</b> Large spade lug fits older relay terminal blocks, or STATES® Company FTP10 or FTP14 Test paddles, ABB or General Electric test plugs with screw down terminals.	
	
Lug adapter, red, 6.2 mm, use with test leads up to 1000 V/20 Amps CAT II.	684002
Lug adapter, black, 6.2 mm, use with test leads up to 1000 V/20 Amps CAT II.	684003

Description	Part No.
<b>Alligator/Crocodile Clip:</b> Excellent for test connections to terminal screws and pins where spade lugs cannot be used.	
	
Alligator clip, red, use with test leads up to 1000 V/32 Amps CAT III.	684006
Alligator clip, black, use with test leads up to 1000 V/32 Amps CAT III.	684007

<b>Flexible Test Lead Adapter:</b> Use with rail-mounted terminals or screw clamp connections where spade lugs and crocodile/alligator clips cannot be used.	
	
Flexible test lead adapter, black, 1.8 mm male pin, use with test leads up to 1000 V/32 Amps CAT III.	90001-845

<b>Flexible Test Lead Adapter with Retractable Insulated Sleeve:</b> Use for connection to old style non-safety sockets with retractable protective sleeve on one end.	
	
Retractable Sleeve Test Lead, red, 50 cm (20") long, use with test leads up to 600 V, 32 Amperes CAT II.	90001-843
Retractable Sleeve Test Lead, black, 50 cm (20") long, use with test leads up to 600 V, 32 Amperes CAT II.	90001-844

<b>In-Line Fused Test Lead:</b> Use with high speed binary outputs 5 or 6 ("P" Option) to protect for accidental switching of currents higher than 1 Amp.	
	
Test lead, blue, in-line 500 mA fuse protection, 200 cm long (78.7").	568026

<b>In-Line Fused Test Lead:</b> Use with ("P" Option) Battery Simulator output to protect for accidental connection to substation battery.	
	
Test lead, black, in-line 3.15 A fuse protection, 200 cm long (78.7").	568025

<b>In-Line Resistor Test Lead:</b> Use with old solid state relays with "leaky" SCR trip gates.	
	
Test lead, red, in-line 100 k Ohm resistor, use with test leads up to 1000 V / 32 Amps CAT III.	500395

Description	Part No.
<b>STATES® 10 Pole Test Paddle:</b> Use with STATES FMS Test Switch or ABB FT-1 10 pole Test Switch.	
	
Test paddle features knobs which also serve as insulated Ø 4 mm rigid socket accepting spring loaded Ø 4 mm plugs with rigged insulating sleeve, or retractable sleeve. Use with test leads up to 600 V, 32 Amperes CATII.	<b>V1TP10</b>

<b>STATES® 10 Pole Test Paddle Attachment:</b> Use with STATES V1TP10 Test Paddle.	
	
Test paddle attachment provides an additional 10 insulated connection points for front connection, as well as the standard top connections for test leads. Adapter can provide convenient parallel test connections of test currents to two terminals at one time. Use with test leads up to 600 V, 32 Amperes CAT II.	<b>TPA10</b>

Transit Case	
<b>Hard-Sided Transit Case:</b> Includes custom designed foam inserts for the SMRT unit and accessory case. Transit case includes retractable handle, polyurethane wheels with stainless steel bearings, double-throw latches, fold-down handles, and stainless steel hardware and padlock protection, with O-ring seal making the case water-tight, with an IP 67 rating. Tested and certified to US Department of Defense Standards for impact, vibration, and low/high storage temperatures. The case is small, and weighs only 25 pounds (11.25 kg). With a three channel SMRT 36 it is light enough to check as luggage on commercial airliners.	
	
Rugged, hard-sided transit case (1ea).	<b>1001-632</b>

Description	Part No.
<b>Example Configurations</b>	
	
For customers in <b>North America, Central America, Japan, Philippines, South Korea, Taiwan, Thailand, Venezuela, Virgin Islands</b> , and other countries that use standard NEMA type power outlets of 100, 110, 115 or 120 volts at 50/60 Hz. could order a unit with the standard North American power cord. In this example the unit is a SMRT36 three phase unit, with the extra binary I/O and Battery Simulator, with the STVI1, without grounded common returns, no Bluetooth, no IEC61850, with the standard hardware, and with test leads.	The style number would be,  <b>SMRT36 – 30P1FOA051</b>
	
For customers in <b>Austria, Belgium, Finland, France, Germany, the Netherlands, Norway, Portugal, Spain, Sweden, Turkey</b> , and other countries where the CEE 7 standard connector is used could order a unit with the Continental European Power Cord with CEE 7/7 Schuko plug. In this example the unit is a 3 phase unit, with the extra binary I/O and Battery Simulator, without the STVI1, with floating outputs, no Bluetooth, with IEC61850 enabled, with the standard hardware, and with test leads.	The style number would be,  <b>SMRT36-30P0FOE151</b>
	
For customers in <b>United Kingdom, Ireland, Anguilla, Cyprus, Dominica, Gambia, Gibraltar, Malta, Malaysia, Malawi, St. Lucia, St. Vincent, Zambia</b> , and other countries where the UK standard connector is used could order a unit with the UK Power Cord. In this example the unit is a 3 channel unit, with the extra binary I/O and Battery Simulator, with the STVI-1, CE Marked 220-230 V input and floating commons, no Bluetooth, with IEC61850 enabled, with standard hardware, and with test leads.	The style number would be,  <b>SMRT36-30P1COU151</b>
The final example is for countries that have more unique power connectors, which will require international color coded wires ready for appropriate male connectors to be installed like; <b>Australia/New Zealand, Argentina, China, Demark, India, South Africa, Ireland, Israel, Russia, Switzerland, or the United Kingdom</b> . These countries are more likely to order the unit with the international color coded power cord ready for mounting the appropriate male connector. In this example the unit is a 3 phase unit, with the extra binary I/O and Battery Simulator, with the STVI1, with the floating outputs, with Bluetooth, with IEC61850 enabled, with the standard hardware, and with test leads.	The style number would be,  <b>SMRT36 – 30P1F1151</b>



---

**UK**  
Archcliffe Road Dover  
CT17 9EN England  
T +44 (0) 1304 502101  
F +44 (0) 1304 207342

**UNITED STATES**  
4271 Bronze Way  
Dallas TX 75237-1088 USA  
T 800 723 2861 (USA only)  
T +1 214 333 3201  
F +1 214 331 7399

**OTHER TECHNICAL SALES OFFICES**  
Norristown USA, Sydney AUSTRALIA,  
Toronto CANADA, Trappes FRANCE,  
Kingdom of BAHRAIN, Mumbai INDIA,  
Johannesburg SOUTH AFRICA and  
Conjure THAILAND.

**ISO STATEMENT**  
Registered to ISO 9001:2008 Cert no. 510006.002  
**SMRT36\_DS\_EN\_V08**  
[www.megger.com](http://www.megger.com)  
Megger is a registered trademark

# SMRT33

## Megger Relay Test System



- **Small, rugged, lightweight and powerful**
- **Operate with or without a computer**
- **Intuitive manual operation with Smart Touch View Interface**
- **High current, high power output (45 Amps/300 VA rms) per phase**
- **Network interface provides IEC 61850 test capabilities**
- **Fully automated testing using AVTS software**
- **Optional transducer test capability**

### DESCRIPTION

For size and low weight, the SMRT33 is conceivably the smallest, lightest, highest output powered; complete three phase relay test system in the world today. The SMRT33 provides high power in both the voltage and current channels to test virtually all types of protective relays used in heavy industrial, distributed generation and low- to medium-voltage distribution substations. The SMRT33 has the smart combination of high compliance voltage and high current to test all electromechanical, solid-state and microprocessor-based overcurrent relays, including high impedance directional ground overcurrent. In addition, the unit includes capability to test IEC 61850 devices.

The SMRT33 test system has the ability to be manually controlled with Megger's new Smart Touch View Interface™ (STVI). The STVI, with its large, full color, high resolution, TFT LCD touch screen, allows the user to perform manual, steady-state and dynamic testing quickly and easily using the manual test screen, as well as using built-in preset test routines for the most popular relays (see STVI datasheet for details.)

The STVI eliminates the need for a computer when testing virtually all types of relays. Menu screens and touch screen function buttons are provided to quickly and easily select the desired test function.

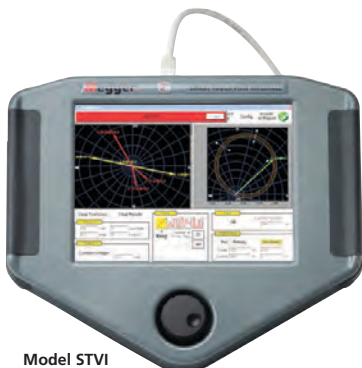

Model STVI

Tests results can be saved to the STVI for download to a memory stick to transfer or print test reports.

For full automatic testing, the SMRT33 may be controlled by Megger Advanced Visual Test Software (AVTS). AVTS is a Microsoft® Windows® XP®/Vista™/7/8 compatible software program designed to manage all aspects of protective relay testing using the new Megger SMRT33, (see AVTS datasheet for details.)

### APPLICATIONS

Each current channel is rated for 30 Amps @ 200 VA continuous, up to 45 amps @ 300 VA for short durations. It has a unique flat power curve from 4 to 30 amps that insures maximum compliance voltage to load at all times. Three currents in parallel can provide up to 135 amps @ 900 VA for testing instantaneous overcurrent relays. With a maximum compliance voltage of 50 volts rms per phase, with just two channels in series, the SMRT33 provides 100 Volts rms of compliance voltage to test high impedance ground overcurrent relays.

Each voltage channel can provide variable outputs of 0-30/150/ 300 volts at 150 VA of output power, and has a unique flat power curve from 30 to 150 volts insuring maximum output power to the load at all times.

Using the Ethernet ports, the SMRT33 is a plug-and-play unit where voltage and current outputs seamlessly synchronize for testing more complex applications, even back-to-back or up to 18 phase current.

### FEATURES AND BENEFITS

**Constant Power Output:** New higher powered voltage-current amplifiers. The current amplifier delivers maximum compliance voltage to the load constantly during the test, and range changing is done automatically under load. This insures better test results, and saves time by not having to turn the outputs off to change

ranges. Constant power output in many cases eliminates the need to parallel or series current channels together to test high burden relays.

**High Output Current:** Provides up to 30 amps at 200 VA per phase continuous. The three current amplifiers can be paralleled to provide a maximum of 135 amperes at 900 VA, for testing instantaneous overcurrent relays.

**New PowerV™ Voltage Amplifier High Power Output:** The SMRT33 provides a new higher VA power output on the voltage channel at the lower critical test voltages (from 30 to 150 volts). Customers who want to test a panel of relays at one time find it impossible using lower VA rated voltage amplifiers.

**Steady-State and Dynamic testing capability:** The SMRT33 provides, either through manual control or computer control, both steady-state and dynamic testing of protective relays. This includes programmable waveforms with DC offset and harmonics.

**Output current and voltage sine waves are generated digitally:** Outputs do not vary with sudden changes in input voltage or frequency, which increases test accuracy and reduces testing time.

**Digital binary inputs and outputs:** The programmable binary inputs, and programmable outputs provide timing and logic operations in real-time with the output voltage and currents. Binary Inputs can be programmed, using Boolean logic, for more complex power system simulations. This provides a low cost, closed loop power system simulator.

**Circuit breaker simulator:** Binary outputs provide programmable normally closed and normally open contacts to simulate circuit breaker operation for testing reclosing relays. Sequence of operation, timing, and lockout are easily tested.

**Performs transient tests:** Perform acceptance or troubleshooting tests by replaying digitally recorded faults or EMT/ATP simulations in the IEEE- C37.111, COMTRADE standard format.

**Perform End-to-End tests:** Using AVTS or STVI software and a portable GPS satellite receiver, the SMRT performs satellite-synchronized end-to-end dynamic multi-state (AVTS or STVI) or playback transient COMTRADE files (AVTS) either for commissioning or troubleshooting tests.

**Wide-ranging output frequency:** The output frequency of the current and voltage channels can be set for any frequency from dc to 1 kHz. Multi-purpose test system saves time and money.

**Three Ethernet ports:** PC/OUT Ethernet port is the primary PC connection port, or used to interconnect multiple SMRT units together for synchronous multi-unit operation. The IN/61850 Ethernet port is used to interconnect multiple SMRT units together for synchronous multi-unit operation or to connect to the IEC 61850 substation bus. The STVI PoE (power over Ethernet) port and is used to connect to the STVI.

**Bluetooth:** Optional Bluetooth provides more flexibility. A wireless interface between the PC and SMRT, in conjunction with the SMRT IEC 61850 Ethernet port, provides the isolation required for a secure substation access interface between the SMRT and the IEC 61850 substation network.

**Universal input voltage:** Operation from 90 to 264 Vac, 50/60 Hz, the SMRT can use virtually any standard source in the world.

**Immediate error indication:** Audible and visual alarms indicate when amplitude or waveforms of the outputs are in error.

**Optional Transducer Testing Capability** – This optional hardware feature (see Ordering Information) provides transducer DC Inputs to test transducers easily and effectively. The STVI software is designed

to automatically recognize the Transducer DC Inputs, and thus provide the Transducer Test Screen when selected. AVTS software comes standard with Transducer Test Modules, which will provide automatic transducer test capability in conjunction with the optional hardware.

**SMRT33 RELAY TESTER**

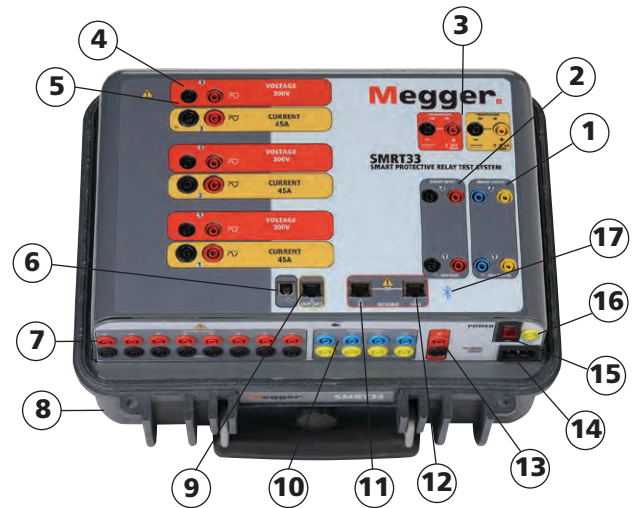

- 1. **Binary Outputs #1 and 2:** Rated for 300 V at 8 amps.
- 2. **Binary Inputs #1 and 2:** Rated 5 to 300 V AC/DC.
- 3. **Transducer Input:** (Optional) DC voltage and DC milliamp input terminals.
- 4. **Voltage Outputs:** 3 channels 0-300 V at 150 VA.
- 5. **Current Outputs:** 3 channels 0-30 amps at 200 VA per phase, up 135 amps at 900 VA single phase.
- 6. **USB 2.0 Interface:** Communication and control port.
- 7. **Additional Binary Inputs:** Provides 8 additional monitor circuits.
- 8. **Rugged Case:** Fiberglass reinforced plastic.
- 9. **PC/OUT:** Ethernet port is the primary PC connection port.
- 10. **Additional Binary Outputs:** Adds 4 outputs. Binary outputs 3 and 4 are rated for 300 V AC/DC, 8 amperes. Binary outputs 5 and 6 are high speed and have an AC/DC voltage rating of 400 volts peak, 1 ampere.
- 11. **IN/61850:** Ethernet port used to chain multiple SMRT units together for synchronous multi-unit operation. This port may also be used for connecting to the IEC 61850 substation bus for testing IEC 61850 devices.
- 12. **STVI:** Ethernet port is a PoE (Power over Ethernet) port and is used to connect to the STVI for manual control.
- 13. **Battery Simulator:** Variable 5 to 250 volts DC output at 100 Watts (4 amperes maximum).
- 14. **Incoming Power/Line Cord Socket:** 100 to 240 V, 50/60 Hz.
- 15. **POWER ON/OFF Switch:** Illuminates when power is on.
- 16. **Protective Earth Ground Jack.**
- 17. **Bluetooth:** Bluetooth® provides wireless control.

**APPLICATIONS SELECTION GUIDE**

	Protective Relays by IEEE Device #	SMRT 33
2	Time Delay	■
21	Distance Single Phase	■
21	Distance Three Phase Open Delta	■
21	Distance Three Phase Wye	■
24	Volts/Hz	■
25	Synchronizing	■
27/59	Under/Over Voltage	■
32	Directional Power Single Phase	■
32	Directional Power Three Phase (Open Delta)	■
37/76	DC Under/Over Voltage/Current	■
40	Loss of Field	■
46	Phase Balance Current	■
46N	Negative Sequence Overcurrent	■
47	Phase Sequence Voltage (Open Delta)	■
50	Instantaneous Overcurrent	<b>Up to 135 Amps</b>
51	Time Delay Overcurrent	<b>Up to 90 Amps</b>
55	Power Factor	■
60	Voltage / Current Balance (Open Delta)	■
67	Directional Overcurrent	■
67N	Ground Directional Overcurrent	■
78	Out of Step	■
79	Reclosing	■
81	Frequency	■
85	Carrier or Pilot Wire	■
87	Differential	■
91	Voltage Directional (Open Delta)	■
92	Voltage and Power Directional (Open Delta)	■
94	Tripping	■

**SPECIFICATIONS<sup>1</sup>**

**Input Power** 100 to 200 volts (±10%) AC, 1Ø, 50/60 Hz, 1000 VA  
 220 to 240 volts (±10%) AC, 1Ø, 50/60 Hz, 1600 VA

**Outputs**

All outputs are independent from sudden changes in voltage and frequency and are regulated so changes in load impedance do not affect the output. All amplifier outputs are isolated or floating. The SMRT units can be ordered with the amplifier common returns tied to chassis ground as an option.

**Output Current Sources**

The SMRT33 per channel output current and power ratings are specified in AC rms values and peak power ratings.

Output Current	Power	Max V/Duty Cycle
1 Ampere	15 VA	15.0 Vrms Continuous
4 Amperes	200 VA (282 peak)	50.0 Vrms Continuous
15 Amperes	200 VA (282 peak)	13.4 Vrms Continuous
30 Amperes	200 VA (282 peak)	6.67 Vrms Continuous
45 Amperes	300 VA (424 peak)	6.67 Vrms 1.5 Seconds

DC 200 Watts

**With three currents in parallel:**

Output Current	Power	Max V/Duty Cycle
12 Amperes	600 VA (848 peak)	50.0 Vrms Continuous
45 Amperes	600 VA (848 peak)	13.4 Vrms Continuous
90 Amperes	600 VA (848 peak)	6.67 Vrms Continuous
135 Amperes	900 VA (1272 peak)	6.67 Vrms 1.5 Seconds

**With two currents in series:**

The compliance voltage doubles to provide 4.0 amperes at 100 Volts rms.

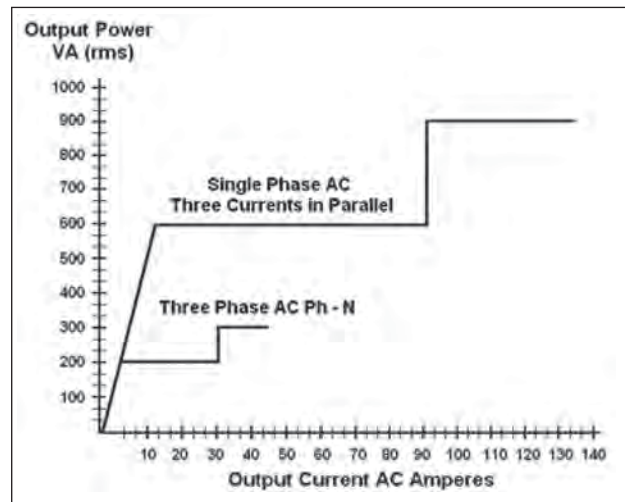

**Current Amplifier – Flat Power Curve**

The SMRT current amplifier provides a unique flat power curve from 4 to 30 Amperes per phase to permit testing of electromechanical high impedance relays, and other high burden applications.

<sup>1</sup> Megger reserves the right to change product specifications at any time.



**AC Voltage Output**

Outputs are rated with the following ranges:

Output Volts	Power	Max I
30 Volts	150 VA	5 Amps
150 Volts	150 VA	Variable
300 Volts	150 VA	0.5 Amps

DC 150 Watts

**Duty Cycle:** Continuous

<sup>3</sup> PowerV™ voltage amplifier output current varies depending on the voltage setting on the 150 Volt range, see curve.

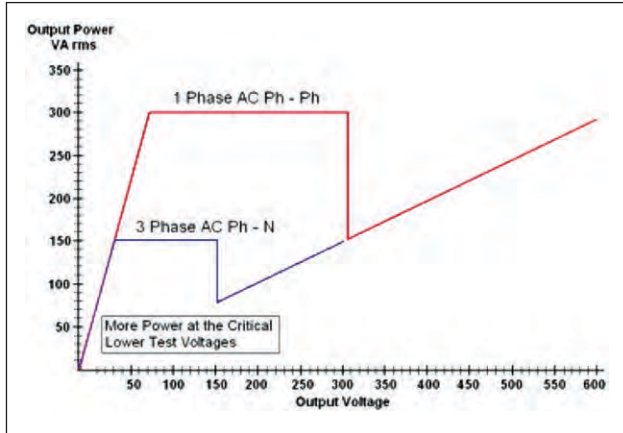

**“PowerV™” Voltage Amplifier - Extended Power Range**

The SMRT voltage amplifier provides a flat power curve from 30 to 150 volts in the 150V range to permit testing of high current applications such as panel testing.

**Phase Angle** Ranges 0.00 to 359.99 degrees, counter clock wise, or clock wise rotation, or 0.00 to ±180.00 degrees

**Accuracy:** ±0.02° typical, ±0.25° max at 50/60 Hz

**Frequency:** The output modules provide a variable frequency output with the following ranges and accuracy

**Ranges**  
 DC  
 0.001 to 1000.000 Hz  
 Output amplifiers can provide transient signals with a range of DC to 10 kHz for transient playback using COMTRADE files.

**Resolution:** .001 Hz

**Frequency Accuracy:** 2.5 ppm typical

**Accuracy:** 25 ppm 0° to 50° C, at 50/60 Hz Maximum

**Total Harmonic Distortion** Less than 0.1% typical, 2% maximum at 50/60 Hz

**Timer:** The timer-monitor Input is designed to monitor and time-tag inputs, like a sequence of events recorder. In addition, the binary input controls enable the user to perform logic and/or functions and conditionally control the binary output relay to simulate circuit breaker, trip, reclose and carrier control operation in real-time. The timer function displays in seconds or cycles with the following range and resolution:

**Seconds:** 0.0001 to 99999.9

**(Auto Ranging)**

**Cycles:** 0.01 to 99999.9

**(Auto Ranging)**

**Accuracy:** ±0.001% of reading, typical. ±2 least significant digit ±0.005% of reading from 0 to 50° C maximum

**Binary Input – Start/Stop/Monitor Gate** To monitor operation of relay contacts or trip SCR, continuity, light is provided for the input gate. Upon sensing continuity the lamp will glow. In addition to serving as wet/dry contacts the binary Inputs may be programmed to trigger binary output sequence(s)

**Number:** The first two VIGENS have 1 each, and the P option adds 8 more

**Input Rating:** up to 300 V AC/DC

**Binary Output** SMRT33 has independent, galvanically-isolated output relay contacts to accurately simulate relay or power system inputs to completely test relays removed from the power system. The binary output simulates normally open/ normally closed contacts for testing breaker failure schemes. The binary output can be configured to change state based on binary input logic.

**High Current Output Relays:** There are two binary output relays on the top panel, and the P option adds 2 more

**AC Rating:** 400 V max., I<sub>max</sub>: 8 amps, 2000 VA max

**DC Rating:** 300 V max., I<sub>max</sub>: 8 amps, 80 W

**Response Time:** <10ms

**High Speed Output Relays:** SMRT33 P option adds 2

**AC/DC Rating:** 400 V peak, I<sub>max</sub>: 1 amp

**Response Time:** <1ms typical

**Battery Simulator** The SMRT33 with the P (Plus) option includes a battery simulator with a variable DC output voltage ranging from 5 to 250 volts at 100 Watts, 4 amps max, providing capability to power up relays with redundant power supplies. Voltage output is controlled via the Smart Touch-View Interface, or through AVTS software

**Waveform Generation** Each output channel can generate a variety of output waveforms such as: DC; sine wave; sine wave with percent harmonics at various phase angles; half waves; square waves with variable duty cycles; exponential decays; periodic transient waveforms from digital fault recorders, relays with waveform recording capability or EMTP/ATP programs, which conform to the IEEE C37.111 COMTRADE standard format

**Metering** Measured output quantities such as AC amperes, AC Volts, DC volts or DC amperes, and time may be simultaneously displayed on the large, color TFT LCD touch screen. The AC and DC outputs display the approximate voltage/current output prior to initiation of the outputs. All accuracies stated are from 10 to 100% of the range at 50/60Hz

**AC Voltage Amplitude**

**Accuracy:** ±0.05 % reading + 0.02 % range typical, ±0.15 % reading + 0.05 % range maximum

**Resolution:** .01

**Measurements:** AC RMS

**Ranges:** 30, 150, 300 V

**AC Current Amplitude**

**Accuracy:** ±0.05 % reading + 0.02 % range typical, ±0.15 % reading + 0.05 % range maximum

**Resolution:** .001/.01

**Measurements:** AC RMS

**Ranges:** 30, 45 A

**DC Voltage Amplitude**

**Accuracy:** 0.1% range typical, 0.25% range maximum

**Resolution:** .01

**Measurements:** RMS

**Ranges:** 30, 150, 300 V

**DC Current Amplitude**

**Accuracy:** ±0.05 % reading + 0.02 % range typical, ±0.15 % reading + 0.05 % range maximum

**Resolution:** .001/.01

**Measurements:** RMS

**Ranges:** 30 A

**DC IN Inputs (Optional Transducer Feature)**

**DC IN Volts**

**Range:** 0 to ±10 V DC

**Accuracy:** ±0.001% reading + 0.005% range typical, ±0.003% reading + 0.02 % range max

**Resolution:** .001

**Measurements:** Average

**DC IN Amperes**

**Range:** 0 to ±1 mA DC, 4 to ±20 mA DC

**Accuracy:** ±0.001% reading + 0.005% range typical, ±0.003% reading + 0.02 % range max

**Resolution:** .001

**Measurements:** Average

**Environmental**

**Operating**

**Temperature:** 32° to 122° F (0 to 50° C)  
SMRT is rated on a continuous duty basis as described by NEMA for test equipment in intermittent service; that is, 30 minutes ON followed by 30 minutes OFF at ambient room temperature 23° C ±5° C (73° F ±10° F). For longer durations or duty cycles at higher operating temperatures see the instruction manual for more information  
**Storage Temperature:** -13° to 158° F (-25° to 70° C)

**Storage**

**Temperature:**

**Relative Humidity:** 5 - 90% RH, non-condensing

**Unit Enclosure** The SMRT unit comes housed in a rugged, virtually indestructible, lightweight and ergonomic enclosure. It features a large oversized rubber cushioned handle, and removable lid for use in tight spaces

**Dimensions**

**With the lid on:** 14.2 W x 7.6 H x 12.0 D in. (360 W x 194 H x 305 D mm)

**With the lid off:** 14.2 W x 7.2 H x 12.0 D in. (360 W x 180 H x 305 D mm)

**IEC Enclosure Rating:** IP30

**Weight**

**With the transit lid on:** 25.4 lb. (11.4 kg)

**With the transit lid off:** 23.3 lb. (10.5 kg)

**Conformance Standards**

**Safety:** EN 61010-1

**Shock:** MIL-PRF-28800F (30 g/11ms half-sine)  
IEC 60068-2-27 (15 g/11 ms half-sine)

**Vibration:** MIL-PRF-28800F (10-500 Hz, 2.05 g rms)  
IEC 60068-2-6 (10-150 Hz, 2 g)

**Transit Drop:** MIL-PRF-28800F (10 drops, 46 cm), ISTA 1A

**Electromagnetic Compatibility**

**Emissions:** EN 61326-2-1, EN 61000-3-2/3, FCC Subpart B of Part 15 Class A

**Immunity:** EN 61000-4-2/3/4/5/6/8/11

**Protection**

Voltage outputs are protected from short circuits and thermally protected against prolonged overloads. Current outputs are protected against open circuits and thermally protected against prolonged overloads.

**Communication Interfaces** Ethernet (3)  
USB  
Bluetooth (optional)

**SOFTWARE****AVTS – STVI Basic**

Every unit comes with **AVTS Basic** software and the PC version of the **STVI Basic** software packages. AVTS Basic version includes online vector control (for single and multi-state timing tests), online ramp control (for automatic ramping of voltage, current, phase angles or frequency) and online click-on-fault (for dynamic tests of impedance relays). Test results may be exported directly to Microsoft Word. AVTS software includes a database for saving test results, which can also provide the necessary information needed for system reliability audits. See AVTS bulletin for more information.

The PC version of the STVI software includes the ability to bring all STVI test data (from other STVI units) into file folders for retrieval, review and printing whenever needed. See STVI bulletin for more information.

**AVTS Advanced**

The AVTS Advanced version includes all the feature in AVTS Basic plus the powerful test editor, dynamic control (includes dynamic end-to-end testing capability, and waveform recording capability), Modbus communication test capability, ASPEN OneLiner™ or Electrocon CAPE™ SS1 File converter for dynamic testing and easy-to-use programming tools for creating and editing test modules. See AVTS bulletin for more information.

**AVTS Professional**

The AVTS Professional version includes all of the features of the Basic and Advanced versions plus some other powerful test tools and features. It includes the DFR Waveform Viewer, One-Touch™ Test for fully automatic tests, and Waveform Digitizer to digitize scanned waveforms of electromechanical over current time curves. See AVTS bulletin for more information.

**IEC 61850 GOOSE**

The SMRT with the GOOSE enabled, in conjunction with the Megger GOOSE Configurator (MGC) software, can be used in the testing or commissioning of IEC 61850 compliant devices. See AVTS bulletin for more information.

**ORDERING INFORMATION**

Style Number Identification

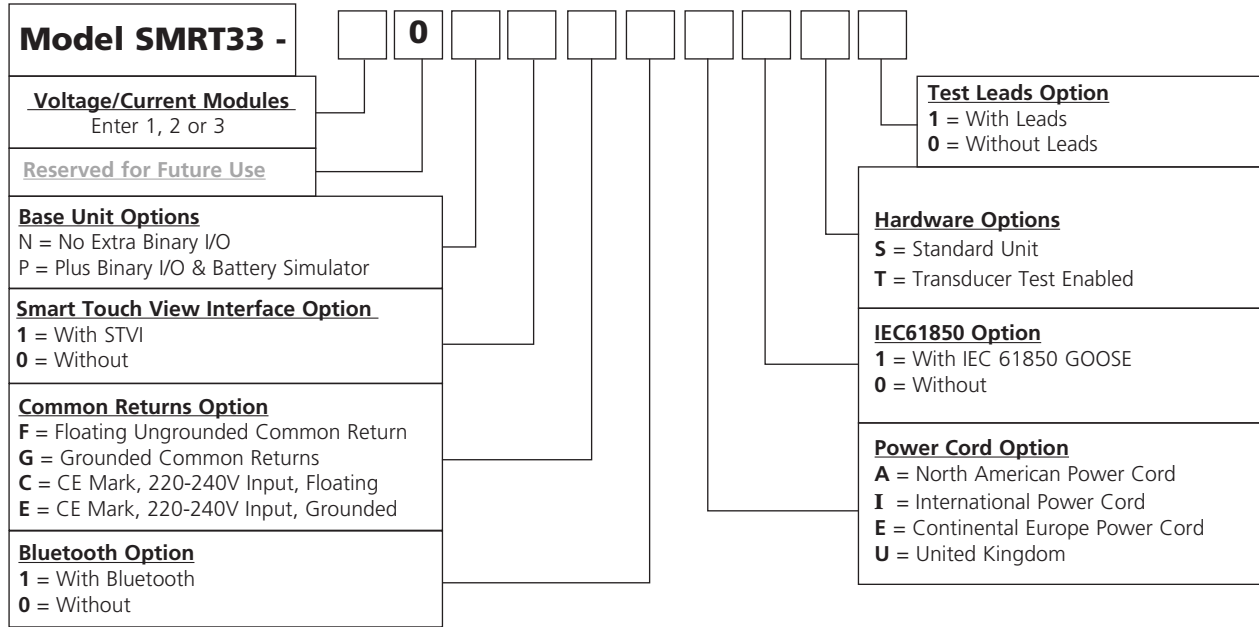

**DESCRIPTION OF SOFTWARE OPTIONS**

Included Software	Part Number
AVTS Basic with STVI Application CD	81302
<b>Software Options</b>	
AVTS Basic with IEC 61850 Megger GOOSE Configurator and STVI Application CD	1002-103
AVTS Advanced with STVI Application CD	81570
AVTS Advanced Test with IEC 61850 Megger GOOSE Configurator and STVI Application CD	1001-106
AVTS Professional with STVI Application CD	81571
AVTS Professional Test with IEC 61850 Megger GOOSE Configurator and STVI Application CD	1002-102

**DESCRIPTIONS OF HARDWARE OPTIONS**

**Voltage/Current Module:** The SMRT33 unit can have up to a total of 3 voltage/current modules. Enter the number of desired Voltage/Current modules **1, 2 or 3**.

**Future:** **0**, Reserved for future use.

**Base Unit Options:** The first two channels provide **1** binary input and **1** binary output each. Enter **N** for No extra binary I/O or battery simulator. For the user who requires the extra binary inputs, outputs and/or the battery simulator enter **P** for Plus option.

**Smart Touch View Interface Option:** Enter the number **1** for the unit to come with the STVI or enter the number **0** for without.

**Common Returns Option:** The floating returns option provides independent, isolated return terminals for each output channel. The grounded common returns option, the return terminals are interconnected internally and connected to chassis ground. The CE Mark **C** and **E** units are designed to operate with an input voltage of 220 to 240 Volts. The F and G units are designed to operate with an input of 100 to 240 V.

**Bluetooth Option:** For customers who wish to have a wireless control of the SMRT unit, enter the number **1** for the unit to come with the Bluetooth option installed. Enter **0** for without.

**Power Cord Option:** Customers can choose which type of power cord they want the unit to come with.

- **A Option:** NEMA 5-15 to IEC60320 C13 connectors, UL & CSA approved for countries with NEMA outlets.
- **I Option:** International color coded wires (light blue, brown and green with yellow stripe) insulation jacket stripped ready for male connector with IEC 60320 C13 connector. CE marked.
- **E Option:** CEE 7/7 "Schuko" plug to IEC 60320 C13 connector is CE marked.
- **U Option:** United Kingdom power cord with IEC 60320 C13 connector, and 13 amp fuse. CE marked.

**IEC 61850 Option:** The SMRT33 (in conjunction with the Megger GOOSE Configurator [MGC] software) can be used in the testing or commissioning of IEC 61850 compliant devices. In order for the SMRT33 to be able to subscribe as well as publish GOOSE messages, the IEC 61850 feature needs to be enabled. Enter the number 1 for the unit to come with the IEC 61850 option enabled. Enter 0 for the unit without IEC 61850 enabled.

**Hardware Options:** **S:** Standard hardware. **T:** With transducer test capability enabled.



**Test Leads Option:** Enter the number **1** for the unit to come with Test Leads. Enter **0** for the unit without Test Leads.

**Test Leads and Accessories**

All units come with a power cord (see power cord option) and Ethernet communication cable, and instruction manual CD. All other accessories varies depending on the options selected, see Table of Accessories.







**DESCRIPTION**

Included Standard Accessories	Part Number
Power Cord - Depending on style number, the unit will come with one of the following power cords:	
Line cord, North American	620000
Line cord, Continental Europe with CEE 7/7 Schuko Plug	50425
Line cord, International color-coded wire	15065
Line cord, United Kingdom	90002-989
Ethernet cable for interconnection to PC, 210cm (7 ft.) long (Qty. 1 ea)	90003-684
Instruction manual CD	80989

**TABLE OF ACCESSORIES**

Accessories are supplied with the selection of the test leads option, and/or the binary input/output/battery simulator option and/or the STVI option. With the test leads option, the number and type

of leads varies depending on the number of channels ordered. If desired, test leads and accessories can be ordered individually. (See description and part numbers below.)

	Optional Accessories Descriptions	STVI, or Binary I/O Bat SIM, or Test Leads Options	One (1) Voltage Current Module	Two (2) Voltage Current Modules	Three (3) Voltage Current Modules	Binary I/O, Battery Simulator Option
	<b>Accessory carry case:</b> Use to carry power cord, Ethernet cable, optional STVI and test leads.	Qty. 1 ea. Part No. 2001-487				
	<b>Sleeved pair of test leads:</b> Keeps the test leads in pairs and from getting entangled. Sleeved test leads, one red, one black, 200 cm (78.7") long, 600 V, 32 Amperes CAT II		Qty. 3 pr. Part No. 2001-394	Qty. 6 pr. Part No. 2001-394	Qty. 2 pr. Part No. 2001-394	Qty. 3 pr. Part No. 2001-394
	<b>Cable/Spade lug adapter (small):</b> Small lug fit most new relay small terminal blocks. <b>Lug adapter: Red,</b> 4.1 mm, use with test leads up to 1000 V/20 amps CAT II		Qty. 3 ea. Part No. 684004	Qty. 6 ea. Part No. 684004	Qty. 12ea. Part No. 684004	Qty. 3 ea. Part No. 684004
	<b>Lug adapter: Black,</b> 4.1 mm, use with test leads up to 1000 V/20 amps CAT II		Qty. 3 ea. Part Number 684005	Qty. 6 ea. Part Number 684005	Qty. 12ea. Part Number 684005	Qty. 3 ea. Part Number 684005
	<b>Jumper lead:</b> Used to common returns together on units with floating ground returns, or parallel of current channels. Jumper lead, black, 12.5 cm (5") long, use with voltage/current outputs, 600 V, 32 Amps CAT II			Qty. 2 ea. Part Number 2001-573	Qty. 4 ea. Part Number 2001-573	
	<b>Sleeved combination voltage test leads:</b> Keeps the test leads from getting entangled. Three common leads connect to the test set, which are interconnected down to one black common to connect to the relay under test. Sleeved three-phase test leads, three red and black, 200 cm (78.7") long, 600 V, 32 amperes CAT II				Qty. 1 ea. Part Number 2001-395	
	<b>Sleeved combination current test leads:</b> Keeps the test leads from getting entangled. Three pairs of leads connect to the test set, with three pairs to connect to the relay under test. Sleeved three-phase test leads, three red and black, 200 cm (78.7") long, 600 V, 32 amperes CAT II				Qty. 1 ea. Part Number 2001-396	

Note that the sleeved combination leads only come with the three module configuration.

## DESCRIPTIONS OF SOFTWARE

**Included Software:** Every unit comes with AVTS Basic and the PC version of the STVI Basic test software packages.

### **AVTS Basic with STVI Application Software (PC Version)**

**Part No.: 81302**

AVTS Basic includes online vector, online ramp and online click-on-fault controls, with the ability to import, save and execute relay specific test modules. The online tools of vector and ramp provide automatic pickup, or dropout tests as well as timing and multi-state dynamic tests. The online click-on-fault tool is used to automatically determine the reach characteristics of single or multi-zone distance relays using shot for single point tests, or ramp, pulse ramp, or binary search tools along user defined search lines. Includes enhanced relay test wizards for overcurrent, differential, voltage, frequency and distance relays.

The powerful STVI screens can be run directly from a PC providing both manual and automatic test capabilities. Intuitive menu screens and buttons are provided to quickly and easily select the desired test function. The manual test screen power-up preset default values maybe automatically set from the user defined configuration screen. The user can select from a variety of test options including manual control using the cursor up down arrows or use the mouse control wheel to vary outputs. In addition a dynamic sequence test includes trip and reclose up to 15 operations. An automatic ramp, pulse ramp, or pulse ramp binary search is built in to determine pickup or drop out of relay contacts, or perform relay specific timing tests using the timing test screen. A vector graph indicates the relative phase angles of all of the outputs. The user may select to have all output amplitudes metered to provide real-time verification of all of the selected outputs, or have setting values displayed. The PC version of the STVI software includes the ability to bring all STVI test data (from other STVI units) into file folders for retrieval and review whenever needed. Each copy of the PC version of the STVI software is licensed for running on one PC. Additional run keys can be purchased separately.

## ADDITIONAL SOFTWARE OPTIONS

### **AVTS Advanced with STVI Application**

**Part No.: 81570**

AVTS Advanced includes all of the features of AVTS Basic in addition to the powerful test editor and test editor tools, which includes the dynamic control (with dynamic end-to-end test capability, and recorder features) for developing sequential tests for virtually any function or measuring element within digital relays. In addition, it also includes SS1 file converter for ASPEN and CAPE dynamic test files, End-to-End DFR playback test macros and basic programming tools for creating and editing test modules. Test files created in advanced test can be used with AVTS Basic.

### **AVTS Professional with STVI Application**

**Part No.: 81571**

Professional test includes all of the features of AVTS Advanced Test version plus the following additional specialized test tools. The DFR waveform viewer and playback tools are used for viewing and analyzing IEEE C37.111 COMTRADE Standard files from digital fault recorders and microprocessor based relays. The DFR Waveform Viewer includes tools to recreate the analog and digital channels for playback into protective relays for troubleshooting or evaluation. It includes the capability to extend the default data as well as start the timer associated with the event to time relay operation. These playback test files can also be used in end-to-end tests to recreate the transient event and evaluate the protection scheme. Test files created in Professional can be used with Advanced test and Basic. Also included is the One-touch test editor control tool for fully automatic testing of microprocessor based relays using VB script files or Modbus communications to automatically download relay settings, and automatically test all the measuring elements within the relay based upon those settings. The waveform digitizer feature is also included in the Professional test version of AVTS. It provides tools to create digital time curves for virtually any electromechanical relay time curve (that do not fit a time curve algorithm). It can even be used for digitizing scanned waveforms from a light-beam chart recorder.

### **IEC 61850 Megger GOOSE Configurator Software**

The Megger GOOSE Configurator (MGC) provides easy to use tools for testing relays and substations using the IEC 61850 protocol. It is an optional software tool available with Basic, Advanced or Professional versions of AVTS Software; see **Descriptions of Software Options** above. The configurator provides relay test engineers and technicians the capability to import parameters from configuration files in the substation configuration Language (SCL) format, and/or capture GOOSE messages directly from the substation bus. All imported GOOSE messages will be unconfirmed messages. Only captured messages are confirmed messages due to the Capture feature of the MGC. Use the MGC Merge feature to compare imported SCL and captured GOOSE messages to verify all GOOSE messages needed to perform tests. Use them to configure the SMRT to subscribe to preselected GOOSE messages by assigning the data attributes to the appropriate binary inputs of the SMRT. Use the configurator to assign the appropriate binary outputs of the SMRT to publish GOOSE messages simulating circuit breaker status. After the appropriate assignments of binary inputs and outputs have been made, the test file can be saved for reuse. This provides both manual and automatic testing of the relay using either the STVI or AVTS software. Use standard test modules in AVTS to perform automatic tests. Use the dynamic control in AVTS Advanced or Professional to perform high speed trip and reclose tests, or use to perform interoperability high-speed shared I/O tests between multiple IED's. The MGC provides mappings of Boolean and Bit Strings and/or simulation of STRuct, Integer/Unsigned, Float and UTC datasets.

**Deluxe Test Leads and Accessories Kit Part No.: 1001-619**

The test leads and test lead accessories are an option. Test leads and accessories can be ordered with the unit or later as a kit. The Deluxe Test Leads and Accessories Kit includes sleeved pairs of leads for use with the extra binary inputs/outputs/battery simulator option, as well as the three phase sleeved combination leads for voltage and current channels. The following test leads and test lead accessories are included in the Deluxe Test Leads and Accessories Kit in quantities shown.

DESCRIPTION	Part No.
<p><b>Sleeved combination voltage test leads:</b> Keeps the test leads from getting entangled.</p> <p>Sleeved three phase test leads, three red and black, 200 cm (78.7") long, 600 V, 32 amperes CAT II (Qty. 1 ea)</p>	<b>2001-395</b>
<p><b>Sleeved combination current test leads:</b> Keeps the test leads from getting entangled.</p> <p><b>Sleeved three phase test leads:</b> three red and black, 200 cm (78.7") long, 600 V, 32 amperes CAT II (Qty. 1 ea)</p>	<b>2001-396</b>
<p><b>Sleeved pair test leads:</b> One red, one black, 200 cm (78.7") long, 600 V, 32 amperes CAT II (Qty. 5 pair)</p>	<b>2001-394</b>
<p><b>Jumper lead:</b> Black, 12.5 cm (5") long, use with voltage/current outputs, 600 V, 32 amps CAT II (Qty. 4 ea.)</p>	<b>2001-573</b>
<p><b>Cable/Spade lug adapter (small):</b> Small lug fits most new relay small terminal blocks.</p> <p><b>Lug adapter: Red,</b> 4.1 mm, use with test leads up to 1000 V/ 20 amps CAT II (Qty. 15 ea.)</p>	<b>684004</b>
<p><b>Lug adapter: Black,</b> 4.1 mm, use with test leads up to 1000 V/20 amps CAT II (Qty. 15 ea.)</p>	<b>684005</b>
<p><b>Accessory case: Black,</b> used to carry test leads and/or STVI (Qty. 1 ea.)</p>	<b>2001-487</b>

**Additional Accessories (Not Included in the SMRT33**

**Test Leads Option or Deluxe Lead Kit)**

Additional Optional Test Leads and Accessories can be ordered individually, see description and part numbers below. The following accessories and part numbers are in quantities of 1 each. Order the appropriate number required.

DESCRIPTION	Part No.
<p><b>Individual (Non-sleeved) test leads:</b> Excellent for widely separated individual terminal test connections.</p> 	
<p><b>Test lead: Red,</b> use with voltage/current output, or binary I/O, 200 cm long (78.7") 600 V/32 amps CAT II</p>	<b>620143</b>
<p><b>Test lead: Black,</b> use with voltage/current output, or binary I/O, 200 cm long (78.7") 600 V/32 amps CAT II</p>	<b>620144</b>

<p><b>Cable/Spadelug adapter (large):</b> Large spade lug fits older relay terminal blocks, or STATES® Company FTP10 or FTP14 Test paddles, ABB or General Electric test plugs with screw down terminals.</p> 	
<p><b>Lug adapter: Red,</b> 6.2 mm, use with test leads up to 1000 V/20 Amps CAT II</p>	<b>684002</b>
<p><b>Lug adapter: Black,</b> 6.2 mm, use with test leads up to 1000 V/20 Amps CAT II</p>	<b>684003</b>

<p><b>Alligator/Crocodile Clip:</b> Excellent for test connections to terminal screws and pins where spade lugs cannot be used</p> 	
<p><b>Alligator clip: Red,</b> use with test leads up to 1000 V/32 Amps CAT III</p>	<b>684006</b>
<p><b>Alligator clip: Black,</b> use with test leads up to 1000 V/32 Amps CAT III</p>	<b>684007</b>

<p><b>Flexible test lead adapter:</b> Use with rail-mounted terminals or screw clamp connections where spade lugs and crocodile/alligator clips cannot be used</p> 	
<p><b>Flexible test lead adapter: Black,</b> 1.8 mm male pin, use with test leads up to 1000 V/32 Amps CAT III</p>	<b>90001-845</b>

DESCRIPTION	Part No.
<p><b>Flexible test lead adapter with retractable insulated Sleeve:</b> Use for connection to old style non-safety sockets with retractable protective sleeve on one end</p> 	
<p><b>Retractable sleeve test lead: Red,</b> 50 cm (20") long, use with test leads up to 600 V, 32 amperes CAT II</p>	<b>90001-843</b>
<p><b>Retractable sleeve test lead: Black,</b> 50 cm (20") long, use with test leads up to 600 V, 32 amperes CAT II</p>	<b>90001-844</b>

<p><b>In-line fused test lead:</b> Use with high speed binary outputs 5 or 6 ("P" Option) to protect for accidental switching of currents higher than 1 amp</p> 	
<p><b>Test lead: Blue,</b> in-line 500 mA fuse protection, 200 cm long (78.7")</p>	<b>568026</b>

<p><b>In-line fused test lead:</b> Use with ("P" Option) battery simulator output to protect for accidental connection to substation battery</p> 	
<p><b>Test lead: Black,</b> in-line 3.15 A fuse protection, 200 cm long (78.7")</p>	<b>568025</b>

<p><b>In-line resistor test lead:</b> Use with old solid state relays with "leaky" SCR trip gates</p> 	
<p><b>Test lead: Red,</b> in-line 100 k Ohm resistor, use with test leads up to 1000 V/ 32 amps CAT III</p>	<b>500395</b>

DESCRIPTION	Part No.
<p><b>STATES® 10 Pole test paddle:</b> Use with STATES FMS test switch or ABB FT-1 10 pole test switch</p> 	
<p>Test paddle features knobs which also serve as insulated Ø 4 mm rigid socket accepting spring loaded Ø 4 mm plugs with rigged insulating sleeve, or retractable sleeve. Use with test leads up to 600 V, 32 amperes CAT II</p>	<b>V1TP10</b>

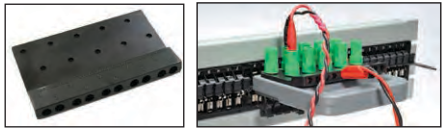
<p><b>STATES® 10 Pole test paddle attachment:</b> Use with STATES V1TP10 test paddle.</p> 	
<p>Test paddle attachment provides an additional 10 insulated connection points for front connection, as well as the standard top connections for test leads. Adapter can provide convenient parallel test connections of test currents to two terminals at one time. Use with test leads up to 600 V, 32 amperes CAT II</p>	<b>TPA10</b>

<p><b>Transit Case</b></p> <p><b>Hard-sided transit case:</b> Includes custom designed foam inserts for the SMRT unit and accessory case. Transit case includes retractable handle, polyurethane wheels with stainless steel bearings, double-throw latches, fold-down handles, and stainless steel hardware and padlock protection, with O-ring seal making the case water-tight, with an IP 67 rating. Tested and certified to US Department of Defense standards for impact, vibration, and low/high storage temperatures. The case is small, and weighs only 25 pounds (11.25 kg). With a three channel SMRT33, it is light enough to check as luggage on commercial airliners.</p> 	
<p>Rugged, hard-sided transit case (1ea).</p>	<b>1001-632</b>



DESCRIPTION	Part No.
<b>Example configurations</b>	
	
<p>Customers in <b>North America, Central America, Japan, Philippines, South Korea, Taiwan, Thailand, Venezuela, Virgin Islands</b>, and other countries that use standard NEMA type power outlets of 100, 110, 115 or 120 volts at 50/60 Hz. could order a unit with the standard North American power cord. In this example the unit is a SMRT33 three-phase unit, with the extra binary I/O and battery simulator, with the STVI1, without grounded common returns, no Bluetooth, no IEC61850, with transducer hardware, and with test leads.</p>	<p>The style number would be,</p> <p><b>SMRT33 – 30P1FOA0T1</b></p>

	
<p>Customers in <b>Austria, Belgium, Finland, France, Germany, the Netherlands, Norway, Portugal, Spain, Sweden, Turkey</b>, and other countries where the CEE 7 standard connector is used could order a unit with the Continental European power cord with CEE 7/7 Schuko plug. In this example the unit is a three-phase unit, with the extra binary I/O and battery simulator, without the STVI1, with floating outputs, no Bluetooth, with IEC61850 enabled, standard hardware and with test leads.</p>	<p>The style number would be,</p> <p><b>SMRT33-30P0FOE1S1</b></p>

DESCRIPTION	Part No.
	
<p>Customers in <b>United Kingdom, Ireland, Anguilla, Cyprus, Dominica, Gambia, Gibraltar, Malta, Malaysia, Malawi, St. Lucia, St. Vincent, Zambia</b>, and other countries where the UK standard connector is used could order a unit with the UK power cord. In this example the unit is a 3-channel unit, with the extra binary I/O and battery simulator, with the STVI-1, CE marked 220-230 V input and floating commons, no Bluetooth, with IEC61850 enabled, with standard hardware and with test leads.</p>	<p>The style number would be,</p> <p><b>SMRT33-30P1COU1S1</b></p>
<p>The final example is for countries that have more unique power connectors, which will require international color coded wires ready for appropriate male connectors to be installed like: <b>Australia/New Zealand, Argentina, China, Demark, India, South Africa, Ireland, Israel, Russia, Switzerland, or the United Kingdom</b>. These countries are more likely to order the unit with the international color coded power cord ready for mounting the appropriate male connector. In this example the unit is a three-phase unit, with the extra binary I/O and battery simulator, with the STVI1, with the floating outputs, with Bluetooth, with IEC61850 enabled, standard hardware and with test leads.</p>	<p>The style number would be,</p> <p><b>SMRT33 – 30P1F11S1</b></p>

**UK**  
 Archcliffe Road Dover  
 CT17 9EN England  
 T +44 (0) 1304 502101  
 F +44 (0) 1304 207342

**UNITED STATES**  
 4271 Bronze Way  
 Dallas TX 75237-1088 USA  
 T 800 723 2861 (USA only)  
 T +1 214 333 3201  
 F +1 214 331 7399

**OTHER TECHNICAL SALES OFFICES**  
 Norristown USA, Sydney AUSTRALIA,  
 Toronto CANADA, Trappes FRANCE,  
 Kingdom of BAHRAIN, Mumbai INDIA,  
 Johannesburg SOUTH AFRICA and  
 Conjure THAILAND.

**ISO STATEMENT**  
 Registered to ISO 9001:2008 Cert no. 510006.002  
**SMRT33\_DS\_EN\_V01**  
[www.megger.com](http://www.megger.com)  
 Megger is a registered trademark

# SMRT1

## Single Phase Relay Test System



- **Small, rugged, lightweight and powerful**
- **Operate with or without a computer**
- **Intuitive manual operation with Smart Touch View Interface**
- **High current, high power (75 Amps/400 VA rms)**
- **Network interface provides IEC 61850 test capabilities**
- **Fully automated testing using AVTS software**

### DESCRIPTION

As a stand-alone unit the SMRT1 has the “smart” combination of high compliance voltage and high current to test electromechanical, solid-state and microprocessor-based overcurrent relays, including voltage controlled, voltage restraint and directional overcurrent; test under/over voltage, single-phase impedance, single-phase power, directional, synchronizing, auto-synchronizing, negative sequence under/over voltage, current balance, frequency, volts/hertz, reclosing, thermal, and various other relays, see the Applications Guide for more.

The SMRT1 test system has the ability to be manually controlled with Megger’s new Smart Touch View Interface™ (STVI). The STVI, with its large, full color, high resolution, TFT LCD touch screen allows the user to perform manual, steady-state and dynamic testing quickly and easily using the manual test screen, as well as using built-in preset test routines for most popular relays.

The STVI eliminates the need for a computer when testing virtually all types of relays. Menu screens and touch screen function buttons are provided to quickly and easily select the desired test function. Tests results can be saved to the PowerDB™ ONBOARD for download

to a memory stick to transfer or print test reports. For full automatic testing the SMRT1 may be controlled by Megger Advanced Visual Test Software (AVTS). AVTS is a Microsoft® Windows® XP®/ Vista™/7/8 compatible software program designed to manage all aspects of protective relay testing using the new Megger SMRT.

### APPLICATIONS

The current channel is rated for 30 Amps @ 200 VA continuous, up to 60 Amps @ 300 VA for short durations. It has a unique flat power curve from 4 to 30 Amps that insures maximum compliance voltage to load at all times. With a high compliance voltage of 50 Volts the SMRT1 has the capability to test high impedance overcurrent relays.

The voltage channel can provide a variable output of 0- 30/150/ 300 Volts at 150 VA of output power, and has a unique flat power curve from 30 to 150 Volts insuring maximum output power to the load at all times. With the voltage channel converted to current, it can perform minimum operating point, slope, and timing on current differential relays, including harmonic restraint transformer differential relays (which can be tested one phase at a time).

It is also designed to operate in conjunction with other SMRT family units. Using the Ethernet ports, SMRT1 is literally a “plug-and-play” unit, where voltage and current outputs can be seamlessly synchronized with other SMRT units voltage and current outputs for testing more complex relays like three phase directional power, distance, loss of excitation, or 6, 9 up to 12 phase current test applications.



Model STVI with SMRT1

**APPLICATIONS SELECTION GUIDE**

Protective Relays by IEEE Device #		SMRT1
2	Time Delay	■
21	Distance Single Phase	■
21	Distance Open Delta	+
21	Distance Three Phase wye	++
24	Volts/Hz	■
25	Synchronizing	+
27/59	Under/Over Voltage	■
32	Directional Power Single Phase	■
32	Directional Power Three Phase (Open Delta)	+
37/76	DC Under/Over Voltage/Current	■
40	Loss of Field	■
46	Phase Balance Current	■
46N	Negative Sequence Overcurrent	■
47	Phase Sequence Voltage (Open Delta)	+
50	Instantaneous Overcurrent	Up to 75 Amps
51	Time Overcurrent	Up to 75 Amps <sup>1</sup>
55	Power Factor	■
60	Voltage/Current Balance (Open Delta)	+
67	Directional Overcurrent	■
67N	Ground Directional Overcurrent	■
78	Out of Step	■
79	Reclosing	■
81	Frequency	■
85	Carrier or Pilot Wire	■
87	Differential	■
91	Voltage Directional (Open Delta)	+
92	Voltage and Power Directional (Open Delta)	+
94	Tripping	■

+ Requires additional SMRT1 for each +

<sup>1</sup> For operating times less than 1.5 seconds. For longer trip times output is rated for 35 Amps continuous with convertible channel in parallel.

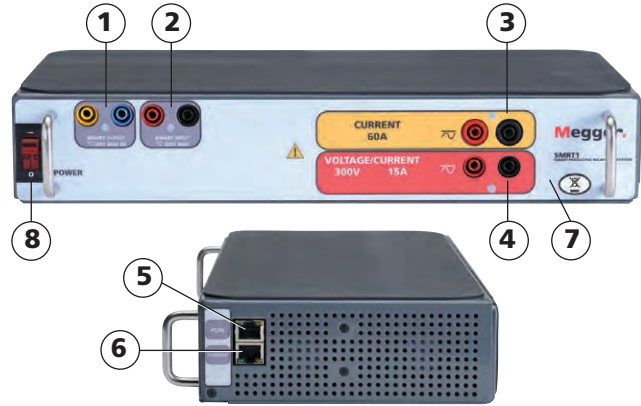

- 1. Binary Output:** Rated for 300 V at 8 Amps.
- 2. Binary Input:** Rated 5 to 300 V AC/DC
- 3. Current Channel:** 0 – 30 Amps at 200 VA continuously, up to 60 Amps at 300 VA for short durations.
- 4. Voltage Channel:** 0 - 300 V at 150 VA, convertible to current rated for 5 Amps at 150 VA continuously, 15 A at 120 VA for short durations.
- 5. PC/IN:** Ethernet Port is the primary PC connection port. This port may also be used for connecting to other SMRT units.
- 6. 61850/OUT:** Ethernet Port may be used to interconnect multiple SMRT units together for synchronous multi-unit operation, or for connecting to the IEC 61850 substation bus.
- 7. Bluetooth:** Bluetooth® provides wireless control.
- 8. POWER ON/OFF:** Switch illuminates when power is on.

**FEATURES AND BENEFITS**

**Constant Power Output** – New higher powered Voltage-Current amplifiers. The current amplifier delivers maximum compliance voltage to the load constantly during the test, and range changing is done automatically under load. This insures better test results, and saves time by not having to turn the outputs off to change ranges. Constant power output in many cases eliminates the need to parallel or series current channels together to test high burden relays.

**High Output Current** – Provides up 30 Amps at 200 VA per phase continuous for timing tests, and can provide up to 60 Amperes at 300 VA for testing instantaneous overcurrent relays.

**New PowerV™ Voltage Amplifier High Power Output** – The SMRT provides a new higher VA power output on the voltage channel at the lower critical test voltages (from 30 to 150 Volts). Customers who want to test a panel of relays at one time find it impossible using lower VA rated voltage sources.

**Convertible Voltage Channel** – Provides second current source for testing single phase current differential relays, including harmonic restraint transformer differential relays. Parallel with main current channel to increase output current to 35 Amps continuous, and up to 75 Amps short time.

**High resolution and accuracy** – Metered outputs provides extremely high accuracy needed for testing a wide variety of devices. Eliminates uncertainty with setting values, with metered values what you see is what you get.

**Steady-State and Dynamic testing capability** – The SMRT1 provides, either through manual control or computer control, both steady-state and dynamic testing of protective relays. This includes programmable waveforms with harmonics.

**Output current and voltage sine waves are generated digitally** – Outputs do not vary with sudden changes in input voltage or frequency, which increases test accuracy and reduces testing time.

**Digital binary input and output** – The programmable binary input, and programmable output provide timing and logic operations in real-time with the output voltage and currents. The Binary Input can be programmed, using Boolean logic, for more complex power system simulations.

**Circuit breaker simulator** – Binary output provide programmable normally closed or normally open contacts to simulate circuit breaker operation for testing reclosing relays. Sequence of operation, timing, and lockout are easily tested.

**Performs transient tests** – Perform acceptance or troubleshooting tests by replaying digitally recorded faults or EMTP/ATP simulations in the IEEE- C37.111, COMTRADE Standard format.

**Perform End-to-End tests** – Using AVTS software and a GPS satellite receiver, the SMRT performs satellite-synchronized end-to-end dynamic multi-state or playback transient COMTRADE files either for commissioning or troubleshooting tests.

**Wide-ranging output frequency** – The output frequency of the current and voltage outputs can be set for any frequency from dc to 1 kHz. Popular test frequencies such as 16.66, 25, 33, 50, 60, 100,120, 125, 150, 180, 250, 300 and 400 Hz are easily set and controlled. Multi-purpose test system saves time and money.

**Two Ethernet ports** – PC/IN Ethernet Port is the primary PC connection port. It is also used when chaining multiple SMRT units together. The 61850/OUT Ethernet Port is primarily used to interconnect multiple SMRT units together for synchronous multi-unit operation, or it may be used to connect to the IEC 61850 substation bus.

**Universal input voltage** – Operation from 90 to 264 VAC, 50/60 Hz, the SMRT can use virtually any standard source in the world.

**Immediate error indication** – Audible and visual alarms indicate when amplitude or waveforms of the outputs are in error.

**BlueTooth** – Optional Bluetooth provides more flexibility. A wireless interface between the PC and SMRT, in conjunction with the SMRT IEC 61850 Ethernet port, provides the isolation required for a secure substation access interface between the SMRT and the IEC 61850 substation network.

**SPECIFICATIONS<sup>1</sup>**

**Input Power**

100 to 240 Volts (± 10%) AC, 1Ø, 50/60 Hz, 700 VA

**Outputs**

All outputs are independent from sudden changes in line voltage and frequency. This provides stable outputs not affected by sudden changes in the mains source. All outputs are regulated so changes in load impedance do not affect the output.

**Output Current**

Output power ratings are specified in AC rms values and peak power ratings.

Output Current	Power	Max V / Duty Cycle
1 Ampere	15 VA	15.0 V rms Continuous
4 Amperes	200 VA (282 peak)	50.0 V rms Continuous
15 Amperes	200 VA (282 peak)	13.4 V rms Continuous
30 Amperes	200 VA (282 peak)	6.67 V rms Continuous
60 Amperes	300 VA (424 peak)	5.00 V rms 90 Cycles
DC 200 Watts		

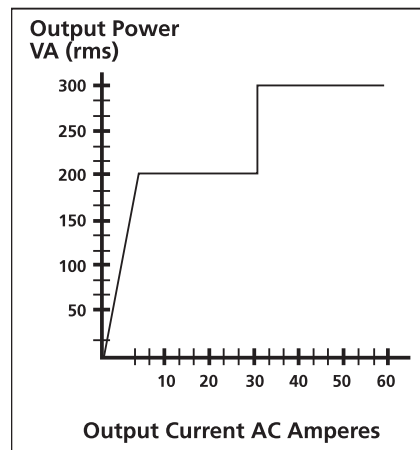

Current Amplifier Output Power Curve

**Current Amplifier - Extended Power Range**

The SMRT current amplifier provides a unique flat power curve from 4 to 30 Amperes to permit testing of electromechanical high impedance relays, and other high burden applications, with an extended operating range up to 60 Amperes at 300 VA rms.

**AC Voltage Output**

Outputs are rated with the following Ranges:

Output Volts	Power	Max I
30 Volts	150 VA	5 Amps
150 Volts	150 VA	See "PowerV™"
300 Volts	150 VA	0.5 Amps
DC 150 Watts		

**Duty Cycle:** Continuous

<sup>1</sup> Megger reserves the right to change product specifications at any time.



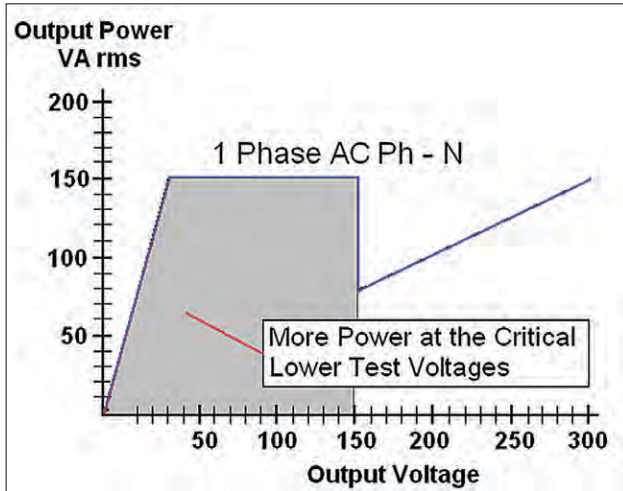

**“PowerV™” Voltage Amplifier - Extended Power Range**

The SMRT voltage amplifier provides a flat power curve from 30 to 150 Volts in the 150V range to permit testing of high current applications such as panel testing.

**Voltage Amplifier in Current Mode:**

The voltage amplifier is convertible to a second current source with the following output capability. Output power ratings are specified in rms values and peak power ratings.

Output Current	Power	Max V Duty Cycle
5 Amperes	150 VA (212 peak)	30.0 Vrms Continuous
15 Amperes	120 VA	8.0 Vrms 90 Cycles

**Phase Angle**

**Ranges:** 0.00 to 359.99 degrees, Counter Clock Wise, or Clock Wise rotation, or 0.00 to ±180.00 degrees  
**Accuracy:** ±0.02° typical, ±0.25° max at 50/60 Hz

**Frequency**

The output modules provide a variable frequency output with the following ranges and accuracy.

**Ranges**

DC  
 0.001 to 1000.000 Hz  
 Output amplifiers can provide transient signals with a range of DC to 10 kHz for transient playback using COMTRADE files.

**Resolution\*:** .0001/.001 Hz

**Frequency Accuracy:**

2.5 ppm typical  
 25 ppm 0° to 50° C, at 50/60 Hz Maximum

**Total Harmonic Distortion**

Less than 0.1% typical, 2% maximum at 50/60 Hz

**Timer**

The Timer-Monitor Input is designed to monitor and time-tag inputs, as a sequence of events recorder. In addition, the binary input controls enable the user to perform logic AND/OR functions, and conditionally control the binary output relay to simulate circuit breaker, trip, reclose and carrier control operation in real-time. The Timer function displays in Seconds or Cycles, with the following range and resolution:

**Seconds:** 0.0001 to 99999.9 (Auto Ranging)  
**Cycles:** 0.01 to 99999.9 (Auto Ranging)  
**Accuracy:** ±0.001% of reading, typical. ±2 least significant digit, ±0.005% of reading from 0 to 50° C maximum

**Binary Input – Start/Stop/Monitor Gate**

To monitor operation of relay contacts or trip SCR, continuity light is provided for the input gate. Upon sensing continuity the lamp will glow. In addition to serving as wet/dry contacts the Binary Input may be programmed to trigger binary output sequence(s).  
**Input Rating:** up to 300 V AC/DC

**Binary Output Relay**

SMRT1 has an independent, galvanically isolated, output relay contact to accurately simulate relay or power system inputs to completely test relays removed from the power system. The binary output simulates normally open / normally closed contacts for testing breaker failure schemes. The binary output can be configured to change state based on binary input logic.

**AC Rating:** 400 V max., **I<sub>max</sub>:** 8 amps, 2000 VA max. breaking capacity  
**DC Rating:** 300 V max., **I<sub>max</sub>:** 8 amps, 80 W  
**Response Time:** < 10ms

**Waveform Generation**

Each output channel can generate a variety of output waveforms such as: DC; sine wave; sine wave with percent harmonics at various phase angles; half waves; square waves with variable duty cycles; exponential decays; periodic transient waveforms from digital fault recorders, relays with waveform recording capability or EMTDP/ ATP programs, which conform to the IEEE C37.111 COMTRADE standard format.

**Metering**

Measured output quantities such as AC Amperes, AC Volts, DC Volts or DC Amperes, and Time may be simultaneously displayed on the large, color TFT LCD, optional STVI touch screen. The AC and DC outputs display the approximate voltage/current output prior to initiation of the outputs.

**AC Voltage Amplitude**

**Accuracy:** ±0.05% reading + 0.02% range typical, ±0.15% reading + 0.05% range maximum  
**Resolution:** .01  
**Measurements:** AC RMS  
**Ranges:** 30, 150, 300V

**AC Current Amplitude**

**Accuracy:** ±0.05% reading + 0.02% range typical, ±0.15% reading + 0.05% range maximum  
**Resolution:** .001/.01  
**Measurements:** AC RMS  
**Ranges:** 30, 60A

**DC Voltage Amplitude**

**Accuracy:** 0.1% range typical, 0.25% range maximum  
**Resolution:** .01  
**Measurements:** RMS  
**Ranges:** 30, 150, 300V

**DC Current Amplitude**

**Accuracy:** ±0.05 % reading + 0.02 % range typical, ±0.15 % reading + 0.05 % range maximum  
**Resolution:** .001/.01  
**Measurements:** RMS  
**Ranges:** 30A

**Convertible Source in AC Current Mode**

**Accuracy:** ±0.05% reading + 0.02% range typical, ±0.15% reading + 0.05% range or ±12.5 mA whichever is greater  
**Resolution:** .001  
**Measurements:** AC RMS  
**Range:** 5, 15A

**Temperature Range**

**Operating:** 32 to 122° F (0 to 50° C)

**Storage:** -40 to 158° F (-40 to 70° C)

**Relative Humidity:** 5 - 90% RH, Non-condensing

**Unit Enclosures**

The SMRT1 unit comes housed in a rugged, metal, lightweight enclosure. IEC Enclosure Rating IP20. Optional enclosure for 19 inch rack mount is available.



Rack mount enclosure includes two BNC connectors on the back panel. These connectors are used to amplify an external analog signal using the SMRT amplifiers. Application of ±10 Volts Peak will provide Full Scale output from the selected output.

**Dimensions**

Standard Enclosure

13.5W x 2.4H x 6.75D in. (34.3W x 6.1H x 17.2D cm)

Rack Mount Enclosure

19W x 2.6H x 8.75D in. (48.3W x 6.6H x 22.2D cm)

**Weight**

Standard Enclosure: 8.9 lb. (4 kg)

Rack Mount Enclosure: 10.85 lb. (4.9 kg)

**Conformance Standards**

**Safety:** EN 61010-1

**Shock:** MIL-PRF-28800F (30g/11ms half-sine)

**Vibration:** MIL-RFP-28800F (5-500Hz, 2.05 g rms)

**Transit Drop:** MIL-RFP-28800F

(10 drops, 20 cm, without carry case)

(10 drops, 46 cm, with optional carry case)

**EMC Emissions:** EN 61326-2-1, EN 61000-3-2/3,

FCC Subpart B of Part15 Class A

**Immunity:** EN 61326-2-1, EN 61000-4-2/3/4/5/6/8/11

**Protection**

Voltage outputs are protected from short circuits and thermally protected against prolonged overloads. Current outputs are protected against open circuits and thermally protected against prolonged overloads.

**Communication Interfaces**

Ethernet (2)

Bluetooth (optional)

**SOFTWARE**

**AVTS – STVI Basic**

Every unit comes with **AVTS Basic** software and the PC version of the **STVI Basic** software packages. AVTS Basic version includes Online Vector control (for single and multi-state timing tests), Online Ramp control (for automatic ramping of voltage, current, phase angles or frequency) and Online Click-On-Fault (for dynamic tests of impedance relays). Test results may be exported directly to Microsoft Word. AVTS software includes a database for saving test results, which can also provide the necessary information needed for system reliability audits. See **AVTS** bulletin for more information.

The PC version of the STVI software includes the ability to bring all STVI test data (from other STVI units) into file folders for retrieval, review and printing whenever needed. See **STVI** bulletin for more information.

**AVTS Advanced**

The **AVTS Advanced** version includes all the features in AVTS Basic plus the powerful Test Editor, Dynamic Control (includes dynamic end-to-end testing capability, and waveform recording capability), ASPEN OneLiner™ or Electrocon CAPE™ SS1 File Converter for dynamic testing, and easy to use programming Tools for creating and editing test modules. See **AVTS** bulletin for more information.

**AVTS Professional**

The **AVTS Professional** version includes all of the features of the Basic and Advanced versions plus some other powerful test tools and features. It includes the DFR Waveform Viewer, One-Touch™ Test, Modbus communication test capability for fully automatic tests, and Waveform Digitizer to digitize scanned waveforms of electromechanical over current time curves. See **AVTS** bulletin for more information.

**IEC 61850 GOOSE**

The SMRT with the GOOSE enabled, in conjunction with the Megger GOOSE Configurator (MGC) software, can be used in the testing or commissioning of IEC 61850 compliant devices. See **AVTS** bulletin for more information.

**ORDERING INFORMATION**

**STYLE NUMBER IDENTIFICATION**

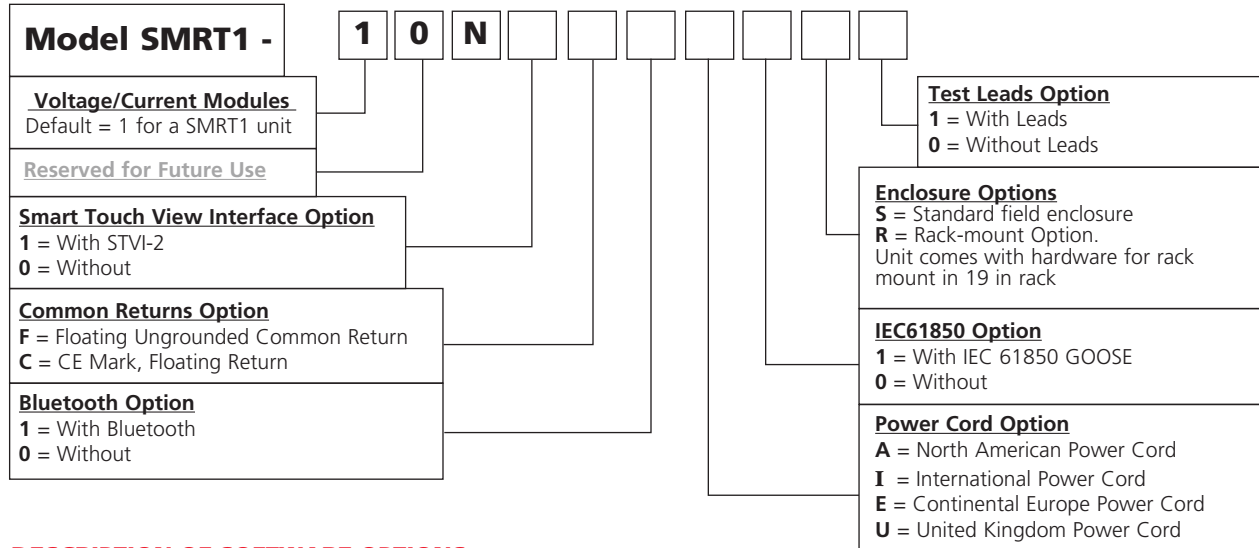

**DESCRIPTION OF SOFTWARE OPTIONS**

Included Software	Part Number
AVTS Basic with STVI Application CD	81302
<b>Software Options</b>	
AVTS Basic with IEC 61850 Megger GOOSE Configurator, and STVI Application CD	1002-103
AVTS Advanced with STVI Application CD	81570
AVTS Advanced Test with IEC 61850 Megger GOOSE Configurator, and STVI Application CD	1001-106
AVTS Professional with STVI Application CD	81571
AVTS Professional Test with IEC 61850 Megger GOOSE Configurator, and STVI Application CD	1002-102

**DESCRIPTIONS OF HARDWARE OPTIONS**

**Voltage/Current Module:** The SMRT1 by default the first digit will always be **1**.

**Future:** **0**, Reserved for future use.

**Base Unit Options:** SMRT1 does not have any Base Unit options. By default this digit is **N** for None.

**Smart Touch View Interface Option:** Enter the number **1** for the unit to come with the STVI, or enter the number **0** for without.

**Common Returns Option:** The SMRT1 unit has only one option, at this time, for the return terminals associated with each output channel. It is **F** for floating returns. **C** is for CE Mark units with floating returns.

**Bluetooth Option:** For customers who wish to have a wireless control of the SMRT unit, enter the number **1** for the unit to come with the Bluetooth option installed. Enter **0** for without.

**Power Cord Option:** Customers can choose which type of power cord they want the unit to come with.

- **A Option** – NEMA 5-15 to IEC 60320 C13 connectors, UL & CSA approved for countries with NEMA outlets.

- **I Option** - International color coded wires (light blue, brown and green with yellow stripe) insulation jacket stripped ready for male connector with IEC 60320 C13 connector. CE marked.
- **E Option** - CEE 7/7 "Schuko" plug to IEC 60320 C13 connector is CE marked.
- **U Option** - United Kingdom power cord with IEC 60321 C13 connector, and 13 Amp fuse. CE marked.

**IEC 61850 Option:** The SMRT1 in conjunction with the Megger GOOSE Configurator (MGC) software can be used in the testing or commissioning of IEC 61850 compliant devices. In order for the SMRT1 to be able to subscribe as well as publish GOOSE messages, the IEC 61850 feature needs to be enabled. Enter the number **1** for the unit to come with the IEC 61850 option enabled. Enter **0** for the unit without IEC 61850 enabled.

**Enclosure Option:** The options are **S** for Standard, and **R** for rack mount. Enter **S**, for Standard, rugged metal field type enclosure. The rack unit will come in a metal enclosure with 19 inch rack mount hardware installed.

**Test Leads Option:** Enter the number **1** for the unit to come with Test Leads. Enter **0** for the unit without Test Leads.

**DESCRIPTION**

Included Standard Accessories	Part Number
Power Cord - Depending on the style number, the unit will come with one of the following,	
Line cord, North American	620000
Line cord, Continental Europe with CEE 7/7 Schuko Plug	50425
Line cord, International color coded wire	15065
Line cord, United Kingdom	90002-989
Ethernet cable for interconnection to PC, 210cm (7 ft.) long (Qty. 1 ea)	90003-684
Instruction manual CD	80989

**Table of Accessories**

Accessories are supplied with the selection of the Test Leads Option and/or the STVI Option. If desired, Test Leads and Accessories can be ordered individually, see description and part numbers below.

	Optional Accessories Descriptions	STVI and/or Test Leads Option	Test Leads Option
	<b>Accessory Carry Case:</b> Use to carry power cord, Ethernet cable, Optional STVI and test leads.	<b>Qty. 1 ea. Part No. 2001-487</b>	
	<b>Sleeved Pair of Test Leads:</b> Keeps the test leads in pairs and from getting entangled. Sleeved Test Leads, one red, one black, 200 cm (78.7") long, 600 V, 32 Amperes CAT II		<b>Qty. 4 pr. Part No. 2001-394</b>
	<b>Cable/Spade Lug Adapter (Small):</b> Small lug fit most new relay small terminal blocks. Lug adapter, red, 4.1 mm, use with test leads up to 1000 V/ 20 Amps CAT II		<b>Qty. 4 ea. Part No. 684004</b>
	Lug adapter, black, 4.1 mm, use with test leads up to 1000 V/ 20 Amps CAT II		<b>Qty. 4 ea. Part Number 684005</b>
	<b>Jumper Lead:</b> Used to common returns together on units with floating ground returns, or parallel of current channels. Jumper lead, black, 12.5 cm (5") long, use with voltage / current outputs, 600 V, 32 Amps CAT II		<b>Qty. 1 ea. Part Number 2001-573</b>

**Descriptions of Software**

Included Software – Every unit comes with AVTS Basic and the PC version of the STVI Basic Test software packages

**AVTS Basic with STVI Application Software (PC Version) Part No.: 81302**

AVTS Basic includes Online Vector, Online Ramp and Online Click-On-Fault controls, with the ability to import, save and execute relay specific test modules. The online tools of Vector and Ramp provide automatic pickup, or dropout tests as well as timing and multi-state dynamic tests. The Online Click-On-Fault tool is used to automatically determine the reach characteristics of single or multi-zone Distance relays using shot for single point tests, or Ramp, Pulse Ramp, or Binary Search tools along user defined search lines. Includes enhanced Relay Test Wizards for; Overcurrent, Differential, Voltage, Frequency and Distance relays.

The powerful STVI screens can be run directly from a PC providing both manual and automatic test capabilities. Intuitive menu screens and buttons are provided to quickly and easily select the desired test function. The Manual Test Screen power-up preset default values maybe automatically set from the user defined configuration screen. The user can select from a variety of test options including manual control using the cursor up down arrows or use the mouse control wheel to vary outputs. In addition a dynamic sequence test includes trip and reclose up to 9 operations. An automatic ramp, pulse ramp, binary search or pulse ramp binary search is built in to determine pickup or drop out of relay contacts, or perform relay specific timing tests using the Timing Test Screen. A vector graph indicates the relative phase angles of all of the outputs. The user may select to have all output amplitudes metered to provide real time verification of all of the selected outputs, or have setting values displayed. The PC version of the STVI software includes the ability to bring all STVI test data (from other STVI units) into file folders for retrieval and review whenever needed. Each copy of the PC version of the STVI software is licensed for running on one PC. Additional run keys can be purchased seperately.

**Additional Software Options**

**AVTS Advanced with STVI Application Part No.: 81570**

AVTS Advanced includes all of the features of AVTS Basic in addition to the powerful Test Editor and test editor tools, which includes the Dynamic Control (with dynamic end-to-end test capability, and Recorder features) for developing sequential tests for virtually any function or measuring element within digital relays. In addition, it also includes SS1 File Converter for ASPEN and CAPE dynamic test files, End-to-End DFR Playback test macros and basic programming Tools for creating and editing test modules. Test files created in Advanced Test can be used with AVTS Basic.

**AVTS Professional with STVI Application Part No.: 81571**



Professional Test includes all of the features of AVTS Advanced Test version plus the following additional specialized test tools. The DFR Waveform Viewer and Playback tools are used for viewing and analyzing IEEE C37.111 COMTRADE Standard files from digital fault recorders and microprocessor based relays. The DFR Waveform Viewer includes tools to recreate the analog and digital channels for playback into protective relays for troubleshooting or evaluation. It includes the capability to extend the predefault data as well as start the timer associated with the event to time relay operation. These playback test files can also be used in end-to-end tests to recreate the transient event and evaluate the protection scheme. Test files created in Professional can be used with Advanced Test and Basic. Also included is the One-Touch Test Editor Control Tool for fully automatic testing of microprocessor based relays using VB script files or Modbus communications for automatic download of settings, to automatically download relay settings, and automatically test all the measuring elements within the relay based upon those settings. The Waveform Digitizer feature is also included in the Professional Test version of AVTS. It provides tools to create digital time curves for virtually any electromechanical relay time curve (that do not fit a time curve algorithm). It can even be used for digitizing scanned waveforms from a light-beam chart recorder.

**IEC 61850 Megger GOOSE Configurator Software**

The Megger GOOSE Configurator (MGC) provides easy to use tools for testing relays and substations using the IEC 61850 protocol. It is an optional software tool available with Basic, Advanced or Professional versions of AVTS Software; see Descriptions of Software Options above. The configurator provides relay test engineers and technicians the capability to import parameters from configuration files in the Substation Configuration Language (SCL) format, and/or capture GOOSE messages directly from the substation bus. All imported GOOSE messages will be unconfirmed messages. Only captured messages are confirmed messages due to the Capture feature of the MGC. Use the MGC Merge feature to compare imported SCL and captured GOOSE messages to verify all GOOSE messages needed to perform tests. Use them to configure the SMRT to subscribe to preselected GOOSE messages by assigning the data attributes to the appropriate binary inputs of the SMRT. Use the configurator to assign the appropriate binary outputs of the SMRT to publish GOOSE messages simulating circuit breaker status. After the appropriate assignments of binary inputs and outputs have been made, the test file can be saved for reuse. This provides both manual and automatic testing of the relay using either the STVI or AVTS software. Use standard test modules in AVTS to perform automatic tests. Use the Dynamic Control in AVTS Advanced or Professional to perform high speed trip and reclose tests, or use to perform interoperability high-speed shared I/O tests between multiple IED's. The MGC provides mappings of Boolean and Bit Strings and/or simulation of STRuct, Integer/Unsigned, Float and UTC datasets.

**Additional Accessories (Not Included in the SMRT1 Test Leads Option)**

Additional Optional Test Leads and Accessories can be ordered individually, see description and part numbers below. The following accessories and part numbers are in quantities of 1 each. Order the appropriate number required.

Description	Part No.
<p><b>Individual (Non-Sleeved) Test Leads:</b> Excellent for widely separated individual terminal test connections.</p> 	
Test Lead, red, use with voltage/current output, or binary I/O, 200 cm long (78.7") 600 V/32 Amps CAT II.	<b>620143</b>
Test Lead, black, use with voltage/current output, or binary I/O, 200 cm long (78.7") 600 V/32 Amps CAT II.	<b>620144</b>
<p><b>Cable/Spade Lug Adapter (Large):</b> Large spade lug fits older relay terminal blocks, or STATES® Company FTP10 or FTP14 Test paddles, ABB or General Electric test plugs with screw down terminals.</p> 	
Lug adapter, red, 6.2 mm, use with test leads up to 1000 V/20 Amps CAT II.	<b>684002</b>
Lug adapter, black, 6.2 mm, use with test leads up to 1000 V/20 Amps CAT II.	<b>684003</b>

Description	Part No.
<p><b>Alligator/Crocodile Clip:</b> Excellent for test connections to terminal screws and pins where spade lugs cannot be used.</p> 	
Alligator clip, red, use with test leads up to 1000 V/32 Amps CAT III.	<b>684006</b>
Alligator clip, black, use with test leads up to 1000 V/32 Amps CAT III.	<b>684007</b>

<p><b>Flexible Test Lead Adapter:</b> Use with rail-mounted terminals or screw clamp connections where spade lugs and crocodile/alligator clips cannot be used.</p> 	
Flexible test lead adapter, black, 1.8 mm male pin, use with test leads up to 1000 V/32 Amps CAT III.	<b>90001-845</b>

<p><b>Flexible Test Lead Adapter with Retractable Insulated Sleeve:</b> Use for connection to old style non-safety sockets with retractable protective sleeve on one end.</p> 	
Retractable Sleeve Test Lead, red, 50 cm (20") long, use with test leads up to 600 V, 32 Amperes CAT II.	<b>90001-843</b>
Retractable Sleeve Test Lead, black, 50 cm (20") long, use with test leads up to 600 V, 32 Amperes CAT II.	<b>90001-844</b>

<p><b>In-Line Fused Test Lead:</b> Use with high speed binary outputs 5 or 6 ("P" Option) to protect for accidental switching of currents higher than 1 Amp.</p> 	
Test lead, blue, in-line 500 mA fuse protection, 200 cm long (78.7").	<b>568026</b>

<p><b>In-Line Fused Test Lead:</b> Use with ("P" Option) Battery Simulator output to protect for accidental connection to substation battery.</p> 	
Test lead, black, in-line 3.15 A fuse protection, 200 cm long (78.7").	<b>568025</b>

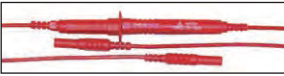
<p><b>In-Line Resistor Test Lead:</b> Use with old solid state relays with "leaky" SCR trip gates.</p> 	
Test lead, red, in-line 100 k Ohm resistor, use with test leads up to 1000 V/ 32 Amps CAT III.	<b>500395</b>



Description	Part No.
<b>Two-Pocket Hard/Soft Carry Case</b>	
<p><b>Two-Pocket Carry Case:</b> Includes custom designed adjustable fabric covered foam insert, which forms two pockets for the SMRT1 and STVI. Carry case includes a zipper pocket on the front to store the POE power supply, Ethernet cables, power cords, and test leads. The unique fabric covered hard/soft sides have 1 inch of padding to protect the SMRT1 and the STVI while in transit. This unique combination provides protection like a hard sided transit case, yet is smaller and light weight like a soft case. The case is small, and weighs only 6 pounds (2.7 kg). The case dimensions are 12 H x 17 W x 10 D in. (30.5 H x 43.2 W x 25.4 cm). With a SMRT1 and STVI it is small and light enough to hand-carry onto commercial airliners.</p>	
	
Rugged, two-pocket Hard/Soft Carry Case (1ea)	<b>2002-468</b>

<b>Single-Pocket Soft-Sided Carry Case</b>	
<p><b>Soft-Sided Carry Case:</b> The single pocket soft-sided carry case has room for one SMRT1, and includes a zipper pocket on the front to store the power cord and test leads. The soft-sided carry case protects the unit from light rain and dust. The padded sides provide moderate protection while in transit. The case is small, and weighs only 1.56 pounds (0.7 kg). The case dimensions are 10 H x 16 W x 6 D in. (25.4 H x 40.6 W x 15.2 cm). It is small and light enough to hand-carry onto commercial airliners.</p>	
	
Rugged, one-pocket Soft-Sided Carry Case (1ea)	<b>2002-567</b>

Description	Part No.
	
Test paddle features knobs which also serve as insulated Ø 4 mm rigid socket accepting spring loaded Ø 4 mm plugs with rigged insulating sleeve, or retractable sleeve. Use with test leads up to 600 V, 32 Amperes CATII.	<b>V1TP10</b>

<b>STATES® 10 Pole Test Paddle Attachment:</b> Use with STATES V1TP10 Test Paddle.	
	
Test paddle attachment provides an additional 10 insulated connection points for front connection, as well as the standard top connections for test leads. Adapter can provide convenient parallel test connections of test currents to two terminals at one time. Use with test leads up to 600 V, 32 Amperes CAT II.	<b>TPA10</b>

# STVI Smart Touch View Interface Handheld Controller for SMRT and MPRT Test Sets

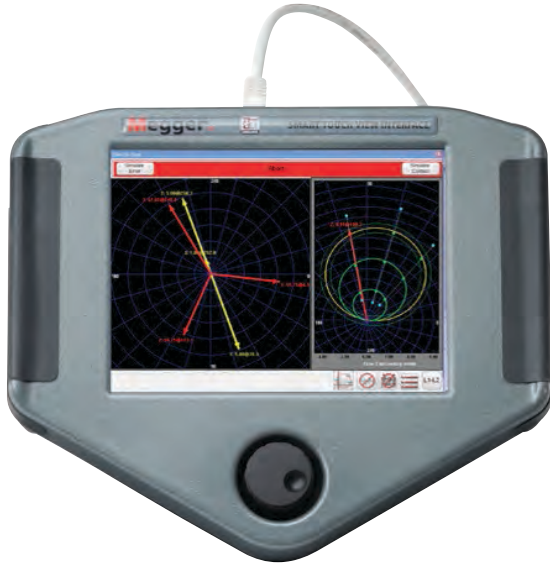

- **New, more powerful and easier to use Click-on-Fault Impedance Relay test screen**
- **Large High Resolution Color TFT LCD touch-screen intuitive smart navigation makes testing relays easier**
- **Designed for either right or left handed operation with control knob centrally located**
- **Automatic Ramp, Pulse Ramp, and Pulse Ramp Binary Search Capability for pick up and dropout tests**
- **Overcurrent Relay Test includes IEC, IEEE and hundreds of Specific Relay Time-Curves Built-in**
- **Dynamic Testing Capability, Multi-Shot Trip and Reclose “Sequencing” test screen**
- **Save/View/Print results from internal PowerDB ONBOARD**

## DESCRIPTION

The Smart Touch View Interface™ (STVI) is Megger’s second generation of handheld controllers for the new SMRT and older MPRT<sup>1</sup> relay test systems. The STVI, with its large, full color, new high resolution, and high definition TFT LCD touch screen allows the user to perform manual, steady-state and dynamic testing quickly and easily using the Manual or Sequencer test screens, as well as using built-in preset test routines for most popular relays.

Ergonomically designed for either right or left hand operation using the rubber cushion grips, the centrally located control knob, and the touch screen, the STVI is extremely easy to use. Use the new built-in stand for single-handed operation. The STVI uses a standard Ethernet cable, and Power Over Ethernet (POE) operation. The STVI includes non-volatile built-in data storage for saving tests and test results. A USB port is provided for transferring test results to your PC.

## APPLICATION

The most significant feature of the STVI is its ability to provide the user with a very simple way to manually test, for both commissioning and maintenance, from the simple overcurrent relay to the most complex relays manufactured today. Manual operation is simplified through the use of a built-in computer operating system and the touch screen. The STVI eliminates the need for a computer when testing virtually all types of relays. Intuitive menu screens and touch screen buttons are provided to quickly and easily select the desired test function.

## Here’s how easy it is

### Manual Test Screen

In the following Manual Test Screen the pre-selected outputs are set using the touch screen, or power-up preset default values maybe automatically set from the user defined configuration screen. The user can select from a variety of test options including manual control using the control dial, a dynamic sequence of tests to include trip and reclose operations, an automatic ramp, pulse ramp, or pulse ramp binary search to determine pickup or drop out of relay contacts, or perform relay specific timing tests. By pressing the ON button, the selected output indicators will change colors indicating which outputs are energized. A vector graph indicates the relative phase angles of all of the outputs. The user

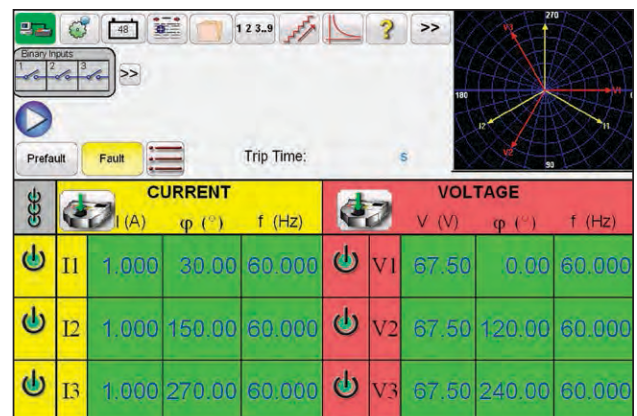

Figure 1. STVI Manual Test Screen

<sup>1</sup> MPRT8415 or MPRT8430 require external power supply adapter

may select to have all output amplitudes metered to provide real time verification of all of the selected outputs, or have setting values displayed.

In the Manual test screen the user can set Prefault and Fault values. The user can toggle back and forth between the two values to monitor contact activity. To do a simple timing test the user can set Prefault time duration in seconds, and then press the Blue Play button. The Prefault values will be applied for the Prefault time, then change to the Fault values and start the Timer running. When the relay trips, it will stop the timer, and may turn selected outputs off depending on the user defined Auto-Off configuration.

**Manual Multi-Phase Test Control**

In the STVI Manual test screen the user can interface with multiple SMRT units to form a multi-phase test system and manually, or dynamically, control all outputs with the STVI. For example, the following is an STVI manual test screen example of two SMRT36 units interconnected using a single Ethernet cable. To the STVI user it appears as a single six-phase test system (or two three phase systems) with manual control of all outputs from the touch screen.

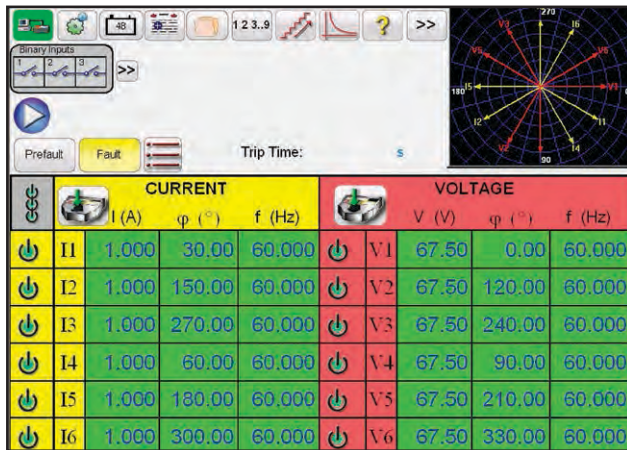

Figure 2. Manual Multi-Phase Test Control screen example

**Auto Ramp, Pulse Ramp and Binary Search Features**

The STVI may be used to determine pickup or dropout of various types of relays. Pressing the Auto Ramp button presents three choices; Step Ramp, Pulse Ramp, and Pulse Ramp



Figure 3. Ramp and Search Tool Bar

Binary Search. The first selection, Step Ramp, will ramp the output by applying a value and then waiting a specific amount of time before incrementing. For example, to automatically ramp output current the user will select the channel to be ramped, input Start and Stop Amplitudes, an Increment (A), and a Delay time in Cycles (B). See the following figure.

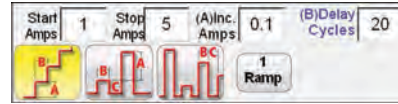

Figure 4. Ramp Setting Example



Figure 5. Pulse Ramp Setting Example

Pulse Ramp will start at user defined prefault condition, increment up or down returning to the prefault condition between each increment. Instead of Delay time the user sets the Pulse Cycles time, which applies the fault value to the relay for the specified time. The user can select a 2<sup>nd</sup>, 3<sup>rd</sup> and 4<sup>th</sup> ramp if desired, changing the size of the increment with each ramp. This feature is most used when doing instantaneous pickup tests. The output current, or voltage, can be incremented in large steps getting to the pickup point quickly, and then reduce the size of the increment to zero-in on the pickup value. This reduces the test time, heating of the relay under test, and provides a very accurate test result. This feature is also used when testing multi zone distance relays using three phase voltage and currents. Set the Pulse Cycles duration just long enough for the intended zone to operate. If you are not sure exactly where the pickup value of the relay is, you can use the Pulse Ramp Binary Search feature.

**Timing Test Feature**

Pressing the Time test button on the top menu bar, the user is presented a menu of relays to test. Built-in timing tests are provided for a wide variety of protective relays, including Overcurrent, Voltage, and Frequency relays. To make it even easier and faster, the STVI has IEEE and IEC standard time curve algorithms built-in. In addition, the STVI also includes time curves and time curve algorithms for hundreds of different specific relays selectable by manufacturer, model number, and curve shape (inverse, very inverse, definite time etc.). In the following example, the G.E. IAC-51 relay with a 2 Amp Tap and a number 5 Time Dial was selected.

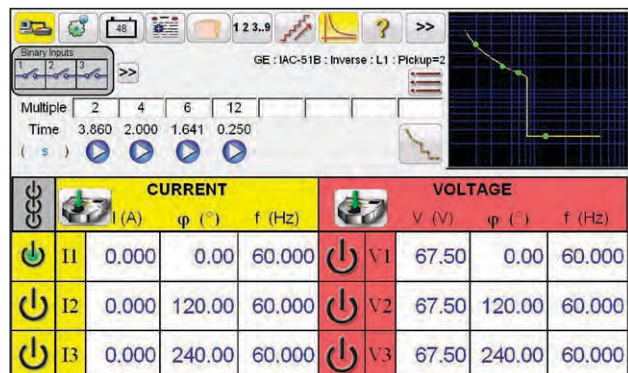



Figure 6. Timing Test Screen for G.E. IAC-51 Inverse Overcurrent Relay

By entering the appropriate values in the setting screen, when the timing test is conducted, the test results will automatically be plotted and compared to the theoretical values from the relay



specific time curve that was selected. If the test Multiple is changed, the appropriate theoretical trip time will change automatically.

**View Test Reports**

To View the test result, press the Add to Reports  button. The user can now enter appropriate information relative to the test in the Test Report header. See the following example report.

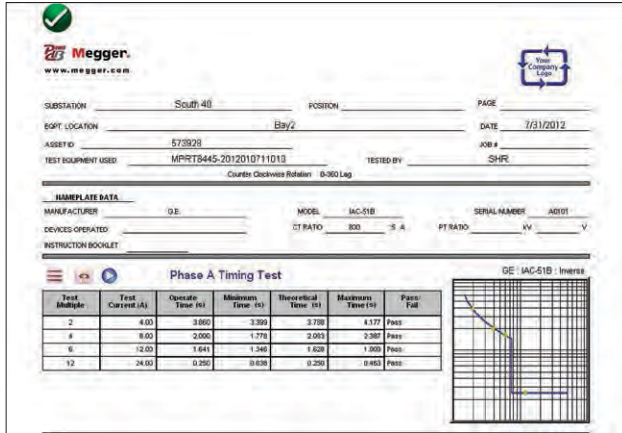



Figure 7. Test Report GE IAC51B Inverse Timing Test

Note that the software automatically compared the Operating Time to the theoretical and made a Pass/Fail determination based upon the manufacturer's time curve characteristic. If the recorded test point(s) is out of specification it appears red in color. If it is within specification it will be green in color. This provides excellent visual As Found reporting. Up to 8 points maybe plotted including Instantaneous trip points. If the data is imported into PowerDB reports can be generated that summarize the comments and failures of every test you perform.

**State Sequence Timing Test Feature**

Pressing the State Sequence button  on the top menu bar takes the user to the Sequence Timing Test Screen. There are 15 programmable steps available in the Sequence Test Screen.

By default, 9 states are already labeled as Prefault, Trip1, Reclose 1, etc. up to Lockout in step 9. Therefore, it is initially setup for a four

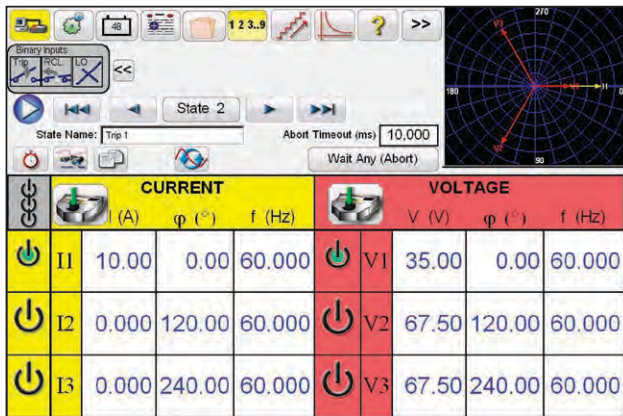

Figure 8. Sequence Test Screen

shot trip, reclose to lockout scenario. The user is free to change the labels, or use the default labels. With each state the user may input values of voltage, current, phase angle, frequency and set the Binary Input sensing for each state. Both single pole and three pole trip can be simulated. There are default values and binary settings for a single phase trip and reclose scenario already programmed in. The user can either use the defaults or change them to suit the application. Press the Timers button to view the Timer Settings and Labels. In addition the user can view where each timer starts and stops in association with each trip and reclose operation (see the following figure).

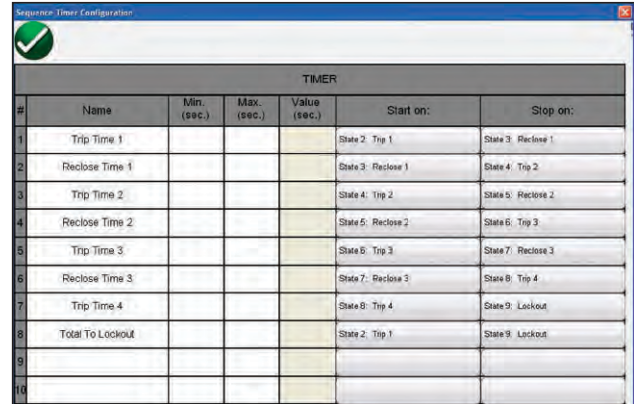



Figure 9. Sequence Timers Settings and Labels Screen

Note that the Total Time to Lockout is also included in the setting and indicates where the total timer starts and stops. This allows for 1, 2, 3, or 4 shots to lockout including reclose times. To set the conditions for each change of state press the Wait button directly under the Timeout window. The user will be presented with several conditional settings to choose from, such as wait milliseconds, wait cycles, wait any contact (OR), and wait all contacts (AND). These are some of the conditions that the unit will take in order to determine when to change to the next state.

To set the Binary Outputs to simulate the 52a and/or 52b contacts press the smaller  "more" button next to the Binary Inputs block to expand the selection window. Press on Show All Binary Outputs, and all the appropriate number of Binary Outputs, along with a select number of Binary Inputs will be displayed. In the prefault state you may choose to have Binary Output 1 contact in the closed condition to simulate breaker closed. Click on Binary Output 1 and the Binary Output setting window will appear. The default setting is Open. Click on the Close Contact Button to simulate breaker closed. Note the Name in the window is defaulted to 1. The user is free to rename it to any name or value (that will fit in the allotted space) by touching the window and use the virtual keyboard.

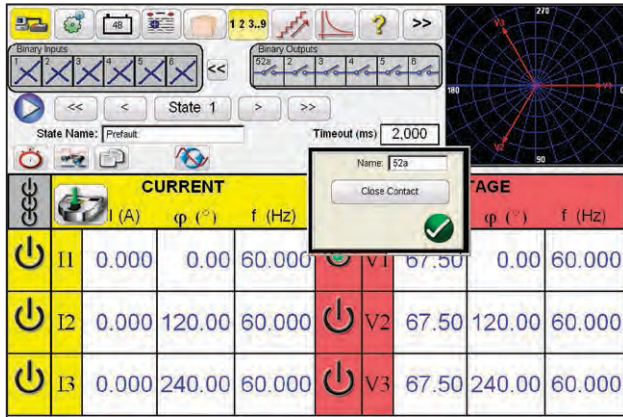

Figure 10. Binary Output Setting Screen

Once all of the Binary Inputs, Outputs, Prefault, Fault and Reclose settings are completed, the user can then press the Preview button to get a visual representation of the voltage and current outputs, as well as a visual of the binary inputs and outputs for each stage of the simulation. The following figure illustrates a sample sequence.

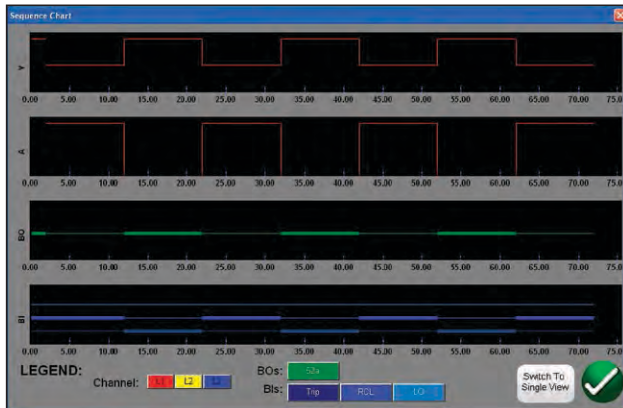

Figure 11. State Sequence Preview Screen

Press the Preview button again to return to the State Sequence Test Screen. To execute the test press the Blue play button. Save and review test results as previously discussed.

**Adding New Features**

The STVI has many powerful test features. However, there are many new features that are still to come. Megger is continuously developing new products and improving existing products. Once a new feature completes certification tests, it may be downloaded from the Megger website into the STVI as a field upgrade.

**New Impedance Relay – The all new Impedance Relay Click-On-Fault**

The all new Click-On-Fault (COF) is located as one of the choices under the large More >> button located next to the Help ? button. The new COF provides automatic tests of Impedance (distance) relays. It includes Ramp, Pulse Ramp, Pulse Ramp Binary Search, and Shot test capabilities.

**Selection of Relay Operating Characteristics**

Select from one the predefined generic relay characteristics of MHO, Half MHO or QUAD (Quadrilateral), or select from the relay specific Library files. The current library includes distance relays from SEL, GE, AREVA, and ABB. There are numerous other library test files

which are still being tested and field evaluated. Therefore, as new relay library files become available a new version of the software will be posted to the website for download.

**Definition of Operating Characteristic and Tests**

There are several new innovations in the new COF that make testing distance relays easier and faster. For example, selecting the Generic MHO characteristic provides the following user input screen.

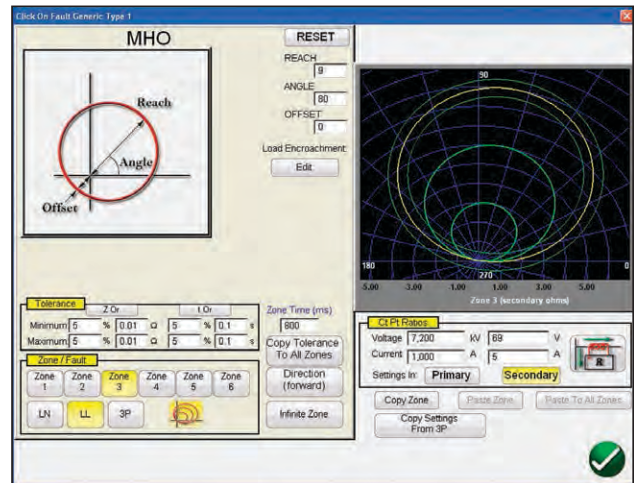

Figure 12. Generic MHO Setting Screen

Here the user selects which Zone (up to 6 zones may be defined), type of fault, direction, tolerance values, inputs the reach, max torque (line) angle, any offset, or load encroachment settings. The software draws the operating characteristic(s) of the relay defined by the user settings. The user may select to view single zone or multiple zones. Pressing the green check button takes the user to the COF test configuration screen, as shown in the following figure.

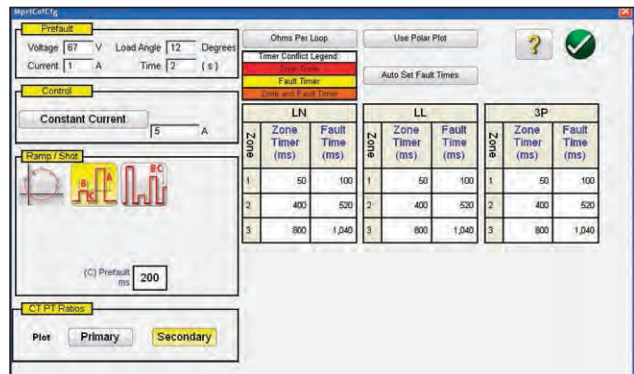

Figure 13. Generic MHO Test Configuration Screen

From this screen the user can select:

**Test Method**

- Linear Ramp
- Pulse Ramp
- Pulse Ramp Binary Search
- Shot

**Test Source Models**

- Constant Voltage
- Constant Current
- Constant Source Impedance

**Displayed Values**

- Primary Values
- Secondary Values

**Prefault**

- Voltage
- Current
- Load Angle
- Duration Time



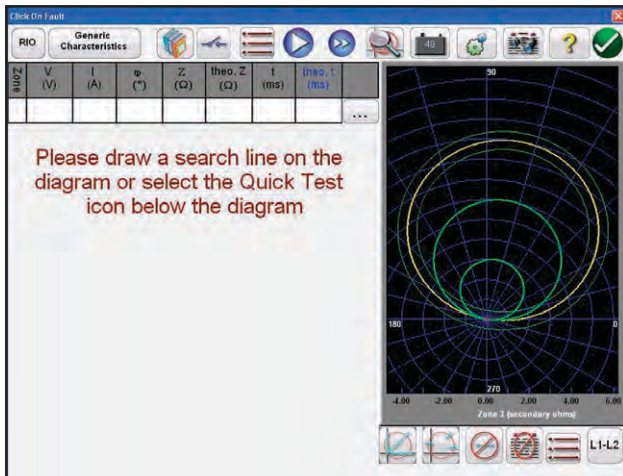

Figure 14. Click on Fault Test Definition Screen

**Creating Search Lines or Shot Test Points**

The user can define up to 10 search lines or test points per fault type, per zone. Test options include;

The *Impedance Test* option provides maximum freedom to the user to select any test line, at any angle, around the operating characteristic to define the desired test line.

The *Origin Test* option the user clicks a point outside the operating characteristic, and the test line will be drawn to the origin or the intercept of the R and X axis.

The *Shots Test Points* option is used to create one or more test points, each to replicate a fault at a particular magnitude and angle. This type of test provides a quick GO, NO/GO test of the relay after a settings change.

The user does not even have to draw the test lines. There are two Quick Test Options the user may select. The first option draws three test lines for any of the selected Quick Test solutions. The second Quick Test the user may select the desired number of test points by pressing the Test Points button and select from the list. If none of the standard phase rotations meets the user’s needs, they can enter the desired phase rotation in the window provided.

**IEC 60255 Test Option**

To comply with regulations which require testing to the IEC 60255 standard, the IEC 60255 option is also provided. All defined test lines will automatically be drawn perpendicular to the relay operating characteristic.

**Prefault Settings**

For testing relays which require a prefault load condition, the user can set the prefault load voltages and currents. This is normally used when testing accelerated tripping or dynamic over-reach characteristics.

**Performing Tests**

The user then simply presses the blue Play button and the test begins. To save even more time the user can select the Play All button and the software will automatically test all define zones and faults in sequence. Based upon the user input the software will calculate all of the fault values and angles for each defined test point, and then make PASS/FAIL determination of the test results.

A real-time test screen will display the relay operating characteristic with the defined test lines in the right half of the screen with the test vector moving in the impedance plane, and in the left half it will display either the test vectors of voltage and currents being applied in real-time, or it will display the Negative, Positive and Zero Sequence vectors being applied, see the following example.

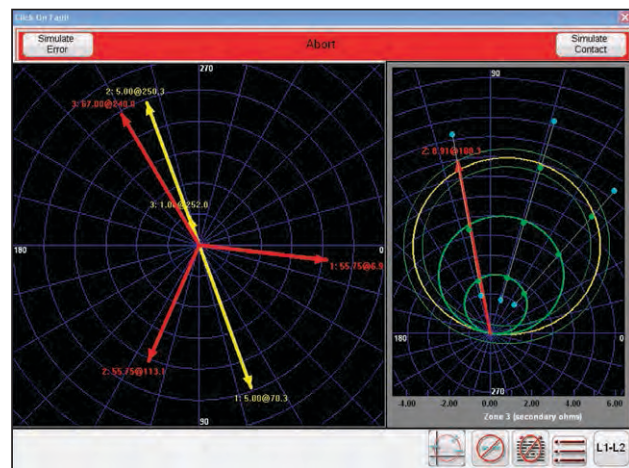

Figure 15. Generic MHO Real-Time Test Screen

The above figure is three zone, Pulse Ramp, Phase L1-L2 fault tests being performed. Note the test amplitudes and angles are displayed in the left half, with the test results displayed in the right half.

**FEATURES AND BENEFITS**

**Large Color TFT LCD touch-screen display** – The STVI features an easy to read high resolution display providing manual control of the test set, and displays measured values of voltage, current, along with phase angle and frequency even in direct sunlight. Color contrasts accentuate vital information. This reduces human error and saves time in testing relays.

**Use with SMRT and MPRT relay test sets** – Operates the new SMRT as well as the MPRT relay test sets. Universal application provides flexibility of use.

**Easy to use for manual tests** – The STVI touch screen is intuitive to use, and requires no special training. A Full Help is built-in to provide users with step by step operation. Touch screen function buttons, with powerful testing tools such as auto ramp, binary search, pulse ramp binary search, or the simple to use control knob may be used to determine pickup or drop out of relay contacts.

**Internal memory** – The STVI provides storage of test set-up screens and test results, which reduces testing time and paper work. Saved test results can be downloaded into the PowerDB ONBOARD software for report generation using the built-in USB port.

**Steady-State and Dynamic test capability** – The STVI in conjunction with either the SMRT or older MPRT provides both steady-state and dynamic testing of protective relays. Set default, fault and simulate circuit breaker operation using the STVI sequence test screen. Perform trip and reclose timing tests with up to 9 operations including lockout. Save trip, reclose times to the internal memory and print out later. The STVI provides complex timing tests without the need of a PC.

**Display screen prompts operator** – The STVI features a touch screen that prompts the user with easy to use function buttons. Single button operation and intuitive ease of use saves time in testing relays and minimizes human error.

**Display screen provides four languages** – The STVI display screen currently prompts the user in English, French, German, and Spanish.

**Immediate error indication** – Audible and visual alarms indicate when amplitude or waveforms of the outputs are in error, such as shorting a voltage channel.

**STVI Specification**

**Input Power:**

The STVI draws power through the Ethernet cable using Power-Over-Ethernet (POE) from the host unit (SMRT36), or from an external Power Over Ethernet power supply and Ethernet interface for use with SMRT1, MPRT8415 or 8430 units.

**Communication Interfaces:**

Ethernet RJ45, 10/100 Mbits/s  
USB Ports: 2

**Power over Ethernet**

IEEE Std 802.3 AF

**Display Screen**

The TFT LCD display provides high resolution, and features Wide Viewing Angle Technology and a large screen with high luminance for reading in direct sunlight.

**Dimensions:** 5.13 H X 6.84 W in (128.2 H X 170.9 W mm), 8.4” Diagonal

**Display:** 262k Colors, backlit, TFT LCD touch screen, Anti-glare surface with hard coating, 800 Cd/m<sup>2</sup> Luminance, 1024 x 768 pixels

**Languages:** English, French, Spanish and German.

**Temperature Range**

**Operating:** 32 to 122° F (0 to 50° C)

**Storage:** -13 to 158° F (-25 to 70° C)

**Relative Humidity:** 5 - 90% RH, Non-condensing

**Unit Enclosure**

The STVI unit comes housed in a rugged, lightweight and ergonomic plastic enclosure. It features large rubber handles, and a built in stand for hands-off operation.

**Dimensions**

11 W x 9.375 H x 1.875 D in. (275 W x 234 H x 46.8 D mm)

**IEC Enclosure Rating:**

IP20

**Weight**

3.9 lb. (1.75 kg)

**CONFORMANCE STANDARDS**

**Safety**

EN 61010-1

**Shock, Vibration and Transit Drop**

Shock: MIL-PRF-28800F (30g/11ms half-sine)

Vibration: MIL-PRF-28800F (5-500Hz, 2.05 g rms)

Transit Drop Test: MIL-PRF-28800F (46cm, 10 impacts)

**Electromagnetic Compatibility**

Emissions: EN 61326-2-1, EN 61000-3-2/3/11/12,

FCC Subpart B of Part 15 Class A

Immunity: EN 61326-2-1, EN 61000-4-2/3/4/5/6/8/11

ORDERING INFORMATION	
Item (Qty)	Cat. No.
Smart Touch View Interface for SMRT33, SMRT36 and SMRT410 Relay Test Systems (1 ea)	STVI-1
Smart Touch View Interface for SMRT1, MPRT 8415 or MPRT 8430 Relay Test System (1 ea)	STVI-2
<b>Included Accessories with STVI-1</b>	
STVI Ethernet Cable Assy., 210 cm (7ft.) long, (1 ea)	90003-684
<b>Included Accessories with STVI-2</b>	
Quick Start Guide (1 ea)	81385
STVI Ethernet Cable Assy., 210 cm (7ft.) long, (1 ea)	90003-684
Power Over Ethernet Power Supply for SMRT1 or MPRT (1 ea)	90001-736

**UK**  
Archcliffe Road Dover  
CT17 9EN England  
T +44 (0) 1304 502101  
F +44 (0) 1304 207342

**UNITED STATES**  
4271 Bronze Way  
Dallas TX 75237-1088 USA  
T 800 723 2861 (USA only)  
T +1 214 333 3201  
F +1 214 331 7399

**OTHER TECHNICAL SALES OFFICES**  
Norristown USA, Sydney AUSTRALIA,  
Toronto CANADA, Trappes FRANCE,  
Kingdom of BAHRAIN, Mumbai INDIA,  
Johannesburg SOUTH AFRICA and  
Conjure THAILAND.

**ISO STATEMENT**  
Registered to ISO 9001:2008 Cert. no. 510006.002  
**STVI\_DS\_en\_V06**  
www.megger.com  
Megger is a registered trademark

# AVTS

## Advanced Visual Test Software

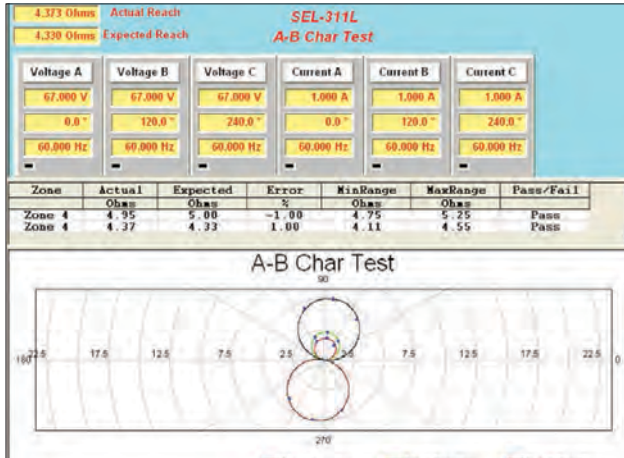

- **Powerful, easy-to-use Microsoft Windows XP/Vista®/7/8 compatible**
- **Designed to manage all aspects of protective relay testing for NERC reporting**
- **Now loaded with more features and capabilities:**
  - **Click-on-Fault**
  - **Dynamic Control with End-to-End test capability**
  - **Binary Search**
  - **Waveform Recorder with COMTRADE Playback with End-to-End test compatability**
  - **SSI File Reader**
  - **One-Touch Test™ with automatic download of setting using VB script or Modbus Communications**
- **Optional IEC 61850 test capability**

### DESCRIPTION

AVTS is a Microsoft® Windows® XP®/Vista®/7 software program designed to manage all aspects of protective relay testing using the new Megger SMRT or MPRT relay test sets. More flexibility has been added as well as some new and powerful features.

AVTS comes in three different levels:

- **Basic**
- **Advanced**
- **Professional**

#### Every SMRT or MPRT unit comes with AVTS Basic.

The **Basic** version includes Online Vector, Ramp and Click-On-Fault controls with the ability to import, save and execute test modules. In addition, the Basic version includes capability to control 9 voltages and 9 currents (3 SMRT36 interconnected units) simultaneously.

The **Advanced** version includes the Test Editor, Dynamic Control, SS1 Converter, End-to-End test macros and basic programming Tools for creating and editing test modules.

The **Professional** version includes all of the features of the Basic and Advanced versions plus some new and powerful features. It includes the DFR Waveform Viewer, One-Touch Test, Modbus, and Waveform Digitizer.

### APPLICATIONS

Using the Online Ramp Control, traditional steady-state tests are easily performed with AVTS by simply applying test quantities to the device under test and automatically ramping the current, voltage, phase angle or frequency.

Using either the Online Ramp, Vector or Dynamic Controls, Dynamic tests can easily be performed. The dynamic test includes setting a pre-fault condition and allowing the software to automatically test/search for the operating characteristic of the relay by selecting one of several available methods. Using Test Wizards or Test Modules, fault types are selected from a pull-down window.

Operating characteristics for virtually any type of relay are easily defined using Mho circles, Lenticular, Tomato characteristics, or a combination of lines, line and slope, time and amplitude, calculated value or theoretical object

(a time-current curve may be scanned into the program using the digitizer feature in either the Advanced or Professional versions of AVTS).

The AVTS Test Screen enables the user to view test values (both theoretical and actual) on one screen. For example, the figure above shows test values, both theoretical and actual results, all on one screen.

The following chart provides an easy reference showing the features of each version of AVTS Software.

<b>AVTS</b>		Basic	Advanced	Professional
Feature	Description			
Online Vector Control	The Online Vector Control allows the user to have direct control of the Relay Test System. Up to sixteen vector states may be created and sequenced back through the test system. Now includes simultaneous control of up to 9 voltages and 9 currents (3 SMRT36 units interconnected).	■	■	■
Online Ramp Control	Preramp (prefault), Ramp 1 and Ramp 2 are available for use to be played back through the test system. <b>Automatically Ramp</b> or <b>Pulse Ramp</b> outputs. PulseRamp provides the capability to determine reach points on multi-zone distance relays without having to defeat the zone timing elements, and provides pre-fault load conditions for relays that require it. Enable timer control with either ramp. Simultaneous control of up to 9 voltages and 9 currents (3 SMRT36 units interconnected).	■	■	■
On-Line Click On Fault	The user can define the type of operating characteristic using the AVTS Theoretical Control or Import files in the RIO file format, then click at a point on the characteristic that they wish to test for, either as a Shot, or using the Search features. If using the Search the test will progress down a user defined test line, either as a ramp or a pulse ramp looking for the relay to operate. Test results appear in the RX diagram along with the theoretical operating characteristic of the relay.	■	■	■
RIO File Format	RIO file import allows the user to import an existing RIO file into the click-on-fault R/X diagram ready to proceed with the test.	■	■	■
DFR Playback	Import and execute relay test modules, which contain DFR playback files created using the DFR Waveform Viewer Tool.	■	■	■
Fault Calculator	Calculate fault values for $\emptyset$ - $\emptyset$ , $\emptyset$ -N, and 3 $\emptyset$ faults. Use line voltage, line Z and angle, relay volts and angle, relay amps and Z0/Z1.	■	■	■
Import, Save, and Execute Test Modules	Import relay test files and execute selected tests. Save results to built-in Microsoft Access compatible data base, and print results.	■	■	■
Overcurrent Wizard	Provides automatic testing of overcurrent relays, including pickup, timing characteristic using IEEE/IEC formulas or actual manufacturers time curves, Instantaneous, DC target and seal-in tests.	■	■	■
Over/Under Voltage Wizard	Provides automatic testing of over and under voltage relays, including pickup, timing characteristic and DC target and seal-in tests.	■	■	■
Distance Wizard	Provides automatic testing of distance relays. $\emptyset$ - $\emptyset$ , $\emptyset$ -G, and 3 Phase faults are available. Test result graphics are displayed in an R X plane.	■	■	■
Differential Wizard	Provides automatic testing current differential relays, including pickup, slope (includes capability to control up to 8 currents for differential characteristic), and 2nd, 3rd and 5th harmonic restraint tests on transformer differential relays.	■	■	■
Directional Wizard	Provides automatic testing capability of directional elements.	■	■	■
Frequency Wizard	Provides automatic testing of under/over frequency relays, including pickup and timing.	■	■	■

		Basic	Advanced	Professional
Feature	Description			
Transducer Testing	AVTS users may create a test for any type transducer using the Test Editor Screen and the Analog Input control tool.	1	■	■
Test Editor	Provides editing tools for modifying tests.	2	■	■
Dynamic Control – Multi-State Playback – End-To-End Tests	Accessed through the Test Editor Screen, the Dynamic Control provides dynamic multi-state testing of relays with more flexibility and choices than Vector Control. A “state” can be voltage(s), current(s), phase angle(s), timers, start and stop the analog recorder, set Boolean logic for the binary inputs, set binary output(s), or even use variables to set values. The test transitions from one state to another after a programmed time delay of either milliseconds or cycles, or for End-to-End tests after a trigger condition. Allows the user to easily build harmonic waveforms with frequencies up to 1000 Hz.	3	■	■
Recorder	In association with the Dynamic Control is a Recorder feature, which not only records the action of the binary inputs and outputs, but it also records the actual analogue waveforms of the SMRT/MPRT voltage and current outputs. Use this new feature to capture and verify analogue output values. Use to monitor Binary Inputs and Outputs to capture and troubleshoot single-pole or three-pole coordination or suspected contact bounce situations. Use to capture multi-state playback to evaluate complex reclosing schemes. It will even record complex waveforms generated by the SMRT/MPRT, which could be used for harmonic evaluations.		■	■
Basic Programming Tool	Provides control tool in the Test Editor. Basic programs can be written using the test system command set for special testing applications.		■	■
SS1 File Converter	SS1 files are generated using Power System Simulation software programs by Electrocon® CAPE™ or Aspen One-liner® . By modeling the power system and using the SS1 files, the relay can then be tested dynamically using realistic system test scenarios.		■	■
Waveform Digitizer	Provides digitizing tools to create digital time curves for old electromechanical relay time curves (that do not fit any time curve algorithm) up to the most complex relay operating characteristics. Good for digitizing scanned waveforms (like from a light-beam chart recorder).			■
DFR Waveform Viewer and Playback	Import, view, modify and replay Digital Fault Recordings or EMTP/ATP simulations that are in the COMTRADE file format. Perform End-to-End tests playing COMTRADE waveforms when triggered by GPS clocks.			■
One-Touch	Test Editor control tool, used in conjunction with specific Megger Test Modules, to download relay settings (into the AVTS settings screen) from microprocessor based relays for full automatic one-touch testing. Used with VB script to auto test SEL relays and new MODBUS to auto test GE UR and selected Multilin relays.	4	4	4
Import Aspen Relay Database®	Capability to import relay settings directly from Aspen Relay Database®			

<sup>1</sup> Standard transducer test modules are provided for Voltage/Current/Watt/VAR and Frequency Transducers in the Library files. For special transducers, editing functions are available using Advanced or Professional versions.

<sup>2</sup> Limited functions to edit properties within the Test Editor window.

<sup>3</sup> End-to-End test module available in Basic Relay Library.

<sup>4</sup> One-Touch test modules available in Relay Library.



**AVTS BASIC VERSION**

There are three versions of AVTS software. **The Basic version is included with each SMRT/MPRT unit.** The Advanced and Professional versions are optional. In addition, the optional Megger GOOSE Configurator may be used with any version of AVTS to conduct automatic tests on IEC 61850 relays. The Basic version includes online Vector, Ramp and Click-On-Fault controls, relay testing wizards for most types of relays, the ability to import, save and execute relay specific test modules created either by Megger or someone else with either an Advanced or Professional version of AVTS 4.1. Basic can also playback a DFR file created using the Professional version of AVTS. The following describes the features of the Basic version of AVTS 4.1.

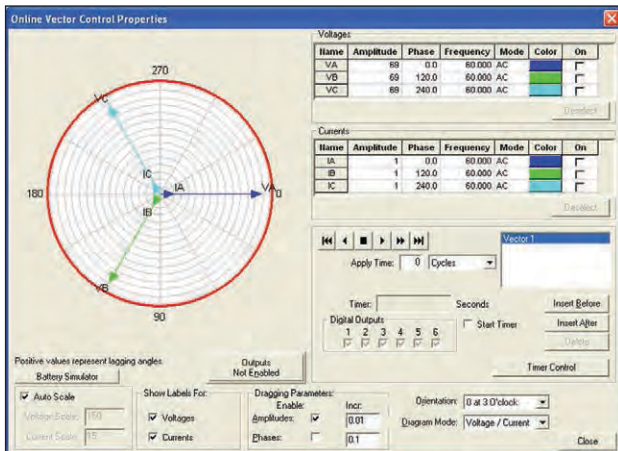

Online Vector Control

**Online Vector Control**

The **Online Vector Control**, launched from the AVTS Tools menu item, allows the user to have direct control of the Relay Test System. With 3 SMRT36 units interconnected provides control of up to **9 voltages and 9 currents simultaneously**. Up to **sixteen vector states** may be created and played back through the Relay Test System. A **timer control** is available to enable starting the Relay Test System timer at the execution of any one of the vector states. The timer stop is typically controlled by an action from one of a device's outputs connected to the appropriate Relay Test System timer stop gate. The default view of the Online Vector Control remains visible during all use of the control.

For **manual setting** of amplitudes and phases, a **gang control** is available through the selection of the vectors (Relay Test System amplifiers) to be controlled. The vectors to be controlled in gang are selected by using the mouse to grab and alter the vector(s) parameters. Vector selection is made by clicking on a vector channel name to highlight that vector with its parameters. Should it be desired to simultaneously control more than one vector, the user will need to click on the wanted vectors while holding the keyboard Ctrl key down to highlight all of the selected vectors (up to 9 voltages or currents with 3 SMRT36 units). The user may then select from the **'Dragging Parameters'** box whether the amplitudes and/or phases of the selected vectors are to be active. Once selected, the user can grab the tip of any of the selected vectors in the polar graph and, while holding the left mouse button down, move the vector(s). The values of the vector(s) will change

graphically and numerically, and simultaneously pass the new values directly to the corresponding Relay Test System amplifiers. Some other unique features are:

**Aux Contact Check Box**- will close an "aux" binary output contact conditional with change from one vector state to another.

**Edit Custom Prefix Command**- available for each vector state and allows entry of a formula, Relay Test System syntax, or other controlling variable for that selected vector state.

**Zoom**- enlarges the polar vector diagram to the full dimensions of the dialog box.

**Favorites** - save a single vector, or a set of multiple vectors, with all the parameters to a desired name for recall at a later time in the Online Vector Control (Basic Version) or the Test Editor Vector Control (requires Advanced version). Save to the name placed in the edit field will retain only the selected vector(s) in the vector list. The Edit Customs Prefix Commands are saved along with the generator parameters.

**Set to Variables** - selection replaces the numeric values for all the vector parameters to known default variable names. This function is more commonly used for the Vector Control used within a test development in the Test Editor (Advanced Version), where the variable names are given values in the Settings Screen, Variable Watch edit field (a powerful programming tool in the Advanced version) in the Test Screen, or in another control in the Test Editor (Advanced version) Screen prior to the Vector control.

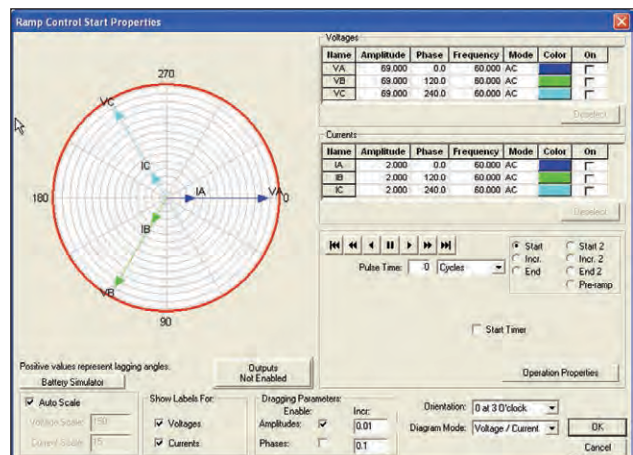

Online Ramp Control

**Online Ramp Control**

The **Online Ramp Control**, launched from the AVTS Tools menu item, allows the user to have direct real time control of the Relay Test System. This control is very similar to the Online Vector Control. However, where the vector control sequences through up to 16 different states, the Ramp Control provides automatic ramping of selected outputs to do pick-up or drop outs tests of amplitude, phase angle or frequency. Pre-ramp, Ramp 1 and Ramp 2 are available for use to be played back through the Relay Test System. With 3 SMRT36 units interconnected provides control of up to **9 voltages and 9 currents simultaneously**. A timer control is available to enable starting the Relay Test System timer at the execution of either of the ramp states. The timer stop is typically controlled by an action from one of a device's outputs connected to the timer stop gate.

Similar to Online Vector Control, Online Ramp Control provides manual ramping of amplitudes and/or phases. The gang control is similar through the selection of the vectors (Relay Test System amplifiers) to be controlled. The outputs to be controlled in gang are selected by using the mouse to grab and alter the parameters (see Online Vector Control for more details). Another feature of the Online Ramp Control is the ability to do Pulse Ramping. One advantage of Pulse Ramping is the capability to determine reach points on multi-zone distance relays without needing the defeat the zone timing elements.

For relays which require a pre-fault load condition prior to applying a fault value, the Online Ramp Control has a Pre-ramp (Pre-fault) state. This feature allows the user to apply the appropriate load values before Pulse Ramping begins. After applying a fault value the Ramp Control returns to the Pre-ramp state before the next value is applied. Many of the same features in the Online Vector Control are also available in the Ramp Control, such as the **Zoom, Set Variables** and **Favorites**.

**Fault Calculator**

The Fault Calculator allows the user to automatically calculate fault quantities for phase-to-phase, phase-to-ground and three-phase faults. The user inputs variables for: line voltage, line Z with angle, relay volts with angle, relay amps and compensation factors K0 or Z0/Z1 ratio. The compensation factor is applied to both the source Z and the line Z for all faults which include ground.

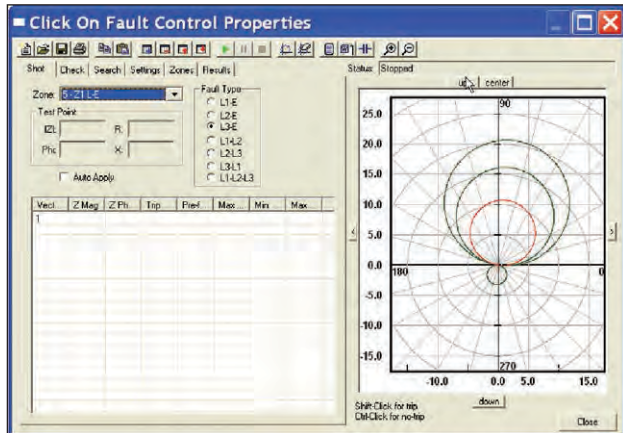

Click-On-Fault Test Screen with Multi-Zone Mho Distance Relay

**On-Line Click-On-Fault Control**

Online Click-On-Fault, launched from the AVTS Tools menu item, allows the user to quickly test impedance relay characteristics. The user can define the type of operating characteristic using the AVTS Theoretical Control, where the user can select a Mho circle, Ellipse, Tomato or virtually any operating characteristic. Characteristics can also be predefined and imported using either the Theoretical Object File Import or RIO File Import. To test the user simply selects the type of fault desired (Line to Earth, Line to Line etc) and clicks to set a test point, either as a Shot, or using the Search. Multiple test points

maybe selected and the software will automatically calculate the appropriate test currents and phase angles based upon the Settings and the Fault Type selected. In the Settings screen the user can define Constant Voltage, Constant Current or Constant Source Z (defined by Source Z, Source Angle and K). If using the Search the test will progress down a line, using click and drag, either as a ramp or a pulse ramp looking for the relay to operate. Test results are automatically displayed for each test point.

**RIO File Import**

In association with the Click-On-Fault test screen, Megger has also included a feature called RIO Import. RIO is a file format that defines the operating characteristic of specific relays. Customers who already have RIO files for their relays can import them into the Click-On-Fault RX diagram ready to test. Shown below is a RIO file import for a SEL 321 relay. Six shot test points are defined.

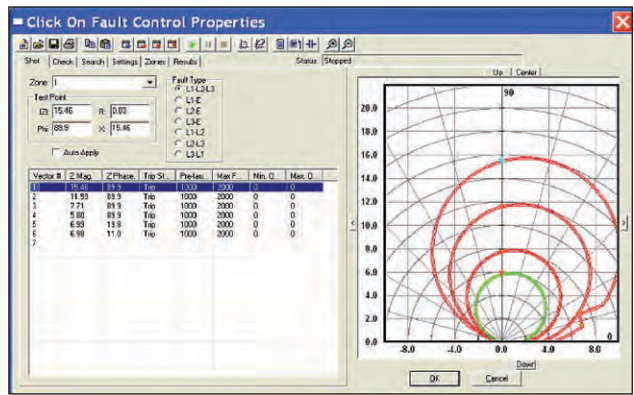

Click-On-Fault RIO Import of SEL 321 Characteristic

**Test Wizards**

All versions of AVTS software come with test wizards. The wizards walk the user through a step by step procedure to create a relay specific test(s). Wizards are available for the most common types of relays such as, Overcurrent, Over/Under Voltage, Frequency, Differential, Distance, Synchronizing and Directional. The following is a brief description of each test wizard.

**Overcurrent Wizard** - Provides automatic pickup, instantaneous pickup and timing. IEEE and IEC time curve algorithms are provided for automatic evaluation of the results. Digitized time curves for various electromechanical overcurrent relays are also available. For North American relays, a dc target and seal-in test is available. A test report will provide pass/fail information of the test results.



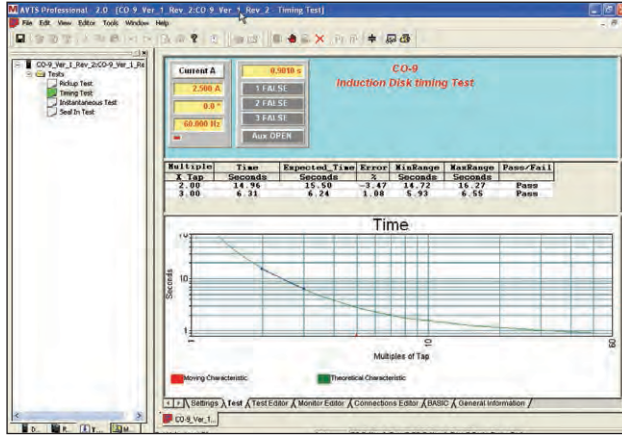

**Over/Under Voltage Wizard** - Provides automatic pickup and timing. A test report will provide pass/fail information of the test results based on user input.

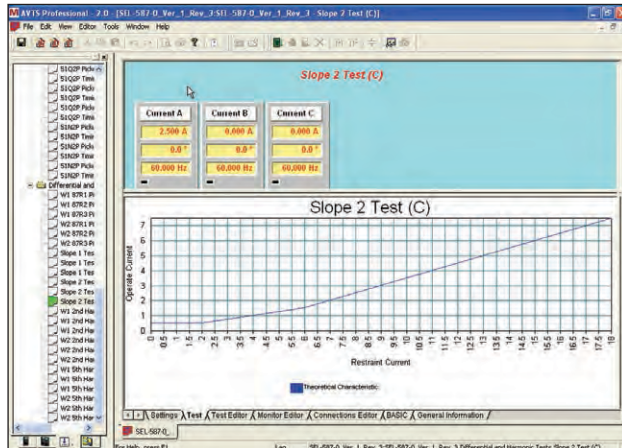

Resized Differential Slope Test Screen

**Differential Wizard** - Perform automatic winding pickup, differential characteristic (slope) test and harmonic restraint tests. In the figure below, the test result screen was resized using the mouse and the windows drag and drop feature. This allows the operator to more closely examine test points and results. The user may then generate a test report with the test results showing pass/fail based upon input by the user.

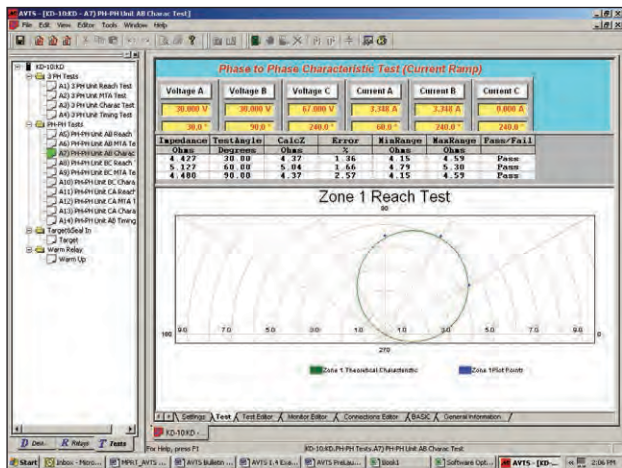

Typical Phase to Phase Characteristic Test

**Distance Wizard** - Perform automatic reach, max angle of torque and characteristic tests on single phase, three phase open delta or three phase Y connected relays. User may choose between fixed voltage and vary current or fix current and vary voltage. In addition, the user may select mho, lens, tomato or other basic distance characteristics using a pull-down menu. The test report will provide pass/fail information based upon user data input.

**Directional Wizard** - Perform automatic pickup test on directional elements. A report will provide test result.

**AVTS Test Module Library**

AVTS Basic includes a Relay Test Library database of almost 400 relay test modules, representing 17 different relay manufacturers. It includes electromechanical relays, solid-state relays, and microprocessor based relays, see Figure below. Test modules include test connection diagrams, all relay settings, and tests for virtually every element in the relay. Test modules automatically make pass/fail determination per the relay in-service settings and manufacturers' specifications. Many of the test modules include One-Touch test capability to automatically download the relay settings. In addition, the Library includes Special Applications test modules for End-to-End tests, testing transducers, and for testing using the symmetrical components calculator. The End-to-End tests include playback of DFR files, as well as multi-state playback using the Dynamic Control with the Recorder feature (Recorder feature records the test set output voltage and current waveforms, with the activity of the binary inputs and outputs).

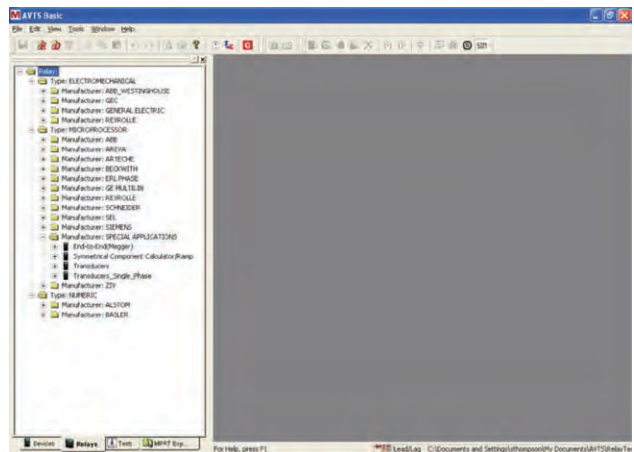

AVTS Relay Test Library Database

**Import, Save, Execute Test Modules**

AVTS Basic users can import test modules generated by Megger, or someone else using the Advanced or Professional versions of AVTS. The user can execute the tests, save results and print results. In addition, users can playback a Digital Fault Record, which has been generated by the Professional version of AVTS.

**Time Saving**

Each relay test module is an extremely valuable product for any relay test technician or engineer. It provides the user with a quick, easy way to test a specific relay to the relay manufacturer's specifications, as well as eliminates the time and costs associated with users having to create their own test routines.

**One-Touch Test™**

The One-Touch Test utilizes a Visual Basic® Script Control tool. The script file works with Megger Test Modules that have been specifically created to make use of this feature. The Script file allows AVTS software to communicate to a microprocessor-based relay via ASCII text serial communication, and download the relay settings into the AVTS relay Setting Screen automatically. Then, using the Group Execute feature in AVTS, automatically test the relay to the actual relay settings with one touch of the mouse button.

**One-Touch Test Modules**

One-Touch Test modules are currently available for a variety of relays. Test modules, which are One-Touch capable, save the user time, money and removes the possibility of human error when having to read over 100+ relay settings.

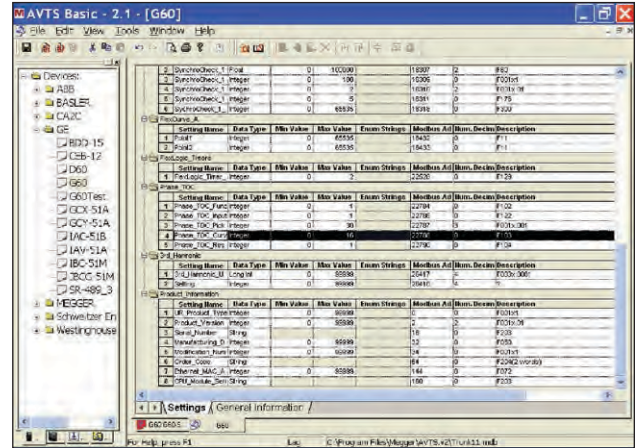

General Electric UR G60 Modbus Device Setting Screen

Electric UR Model G60 relay device settings screen can be seen in the above figure. Note the Modbus address for each setting in the relay is defined in the Device Setting screen. In this test module there are 295 settings that are automatically down loaded with 117 specific tests that can be selected as a sequence test.

**Database**

The database is Windows Access compatible. Data is saved in a conventional tree format to facilitate ease of use.

The following figure illustrates the AVTS navigator Relay tab when AVTS is in use. The relay data has been expanded to illustrate the organization.

The Organization is the method used to geographically locate the relays installed in this database.

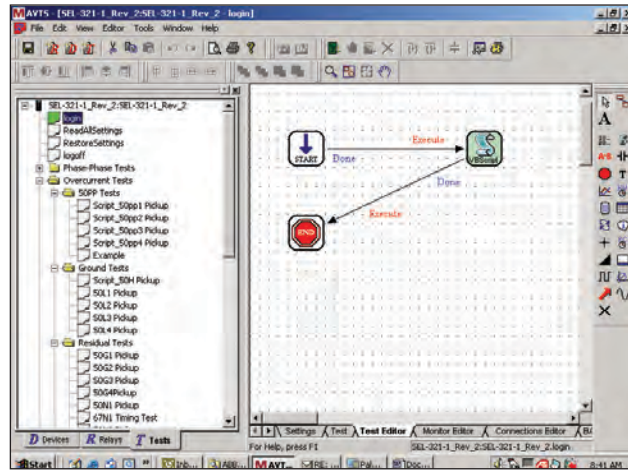

Log-in for SEL-321 Scripted Test Module

**Modbus Communications**

AVTS now has the capability to communicate with relays via the Modbus protocol. This allows the AVTS user the ability to automatically download relay settings from the relay via the Modbus addressing scheme into the AVTS relay setting screen. In addition AVTS can now monitor the relay protection or metering elements via the Modbus communications. This means the user will not need to change the relay outputs, thus test the relay without making any changes to the relay what so ever. Instead of the user having to read the meter values and manually input them into a result screen the software can now read the values automatically. This feature combined with the Sequence Test feature provides fully automatic testing without user intervention. As an example, the General

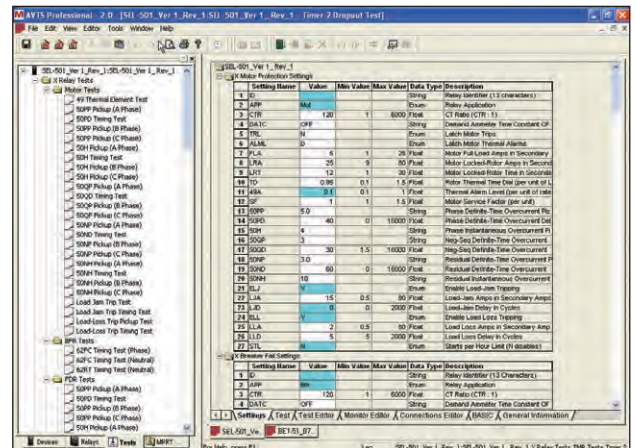

This example shows the organization tree descending by region, then substation, line, panel and finally the actual relay in the panel. The relays installed are then listed under that location. The heirarchical structure of AVTS includes up to 5 levels of organization.



**Historical Test Results**

In addition to showing the location of the relays in the system, the user can also look at the historical test records of any individual relay. This includes relay settings and recorded test results.

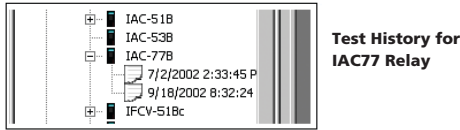

**Test Reports**

Individual test results can be viewed by double clicking on the desired result file. The test report can either be printed, or exported to Microsoft Word for user customized report generation using company logo, company standard format etc. This includes possible report requirements as specified by the National Electric Reliability Corporation (NERC) PRC-005-2 standard.

**AVTS ADVANCED VERSION**

The Advanced version includes all of the features previously described for the Basic version. In addition, it includes the very powerful Test Editor, Connection Editor, Dynamic Control, Analog Recorder, Basic Programming Tool, Modbus communications, SS1 File Connector, End-to-End test macros, and generic pre-constructed relay test modules. Advanced users can also playback a DFR file created by someone using the Professional version of AVTS. The following describes the additional features of the Advanced version of AVTS.

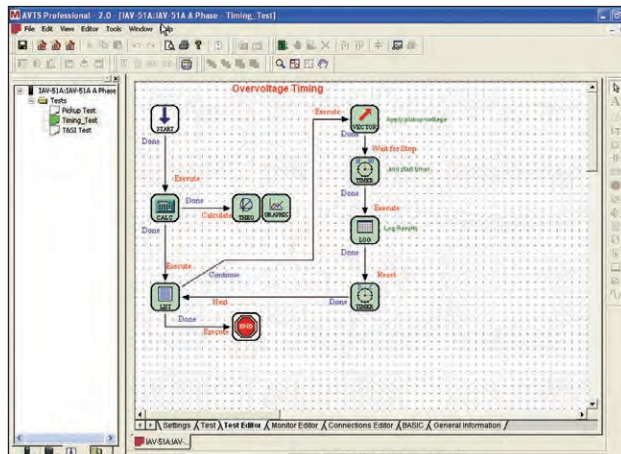

Test Editor Window

**Test Editor**

The real power of AVTS is in the Test Editor window. No more complicated test macros to write or edit. Instead, the user selects from a variety of icons representing various test macro functions. For example, in the Test Editor Window Figure, certain icons are selected and connected using the mouse. The software takes care of the rest. No more theoretical characteristic macros to write

either. Simply click on the appropriate icon and drop into the test editor window. What may have taken weeks to “write” using basic programming now takes only minutes!

In addition, the test wizards automatically assemble and connect the appropriate icons for you. All you need to do is edit the appropriate control function to meet your specific needs. For example, using a right-mouse click on the Ramp Control Icon (in the Test Editor work screen), and then clicking on the Increment button, the user is able to adjust the increment value of each current increment for a pickup test.

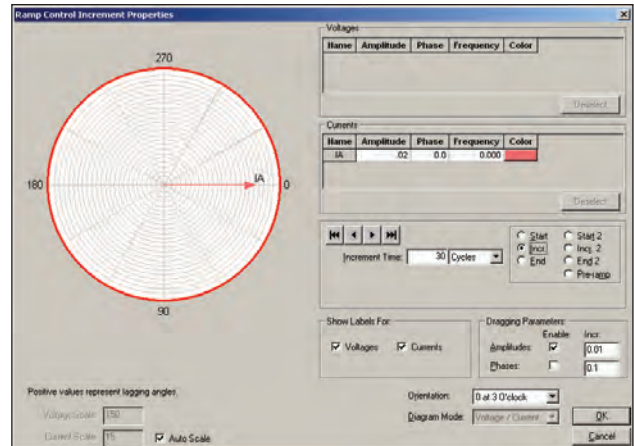

Adjusting Ramp Control - Single Phase Current Increment

**Connections Editor**

A picture is worth a thousand words. It seems like modern relays need a thousand connections today, so the Connections Editor is ideal to show how to connect the test system to the device under test. Powerful graphic tools are available to show test connections (see following Figure).

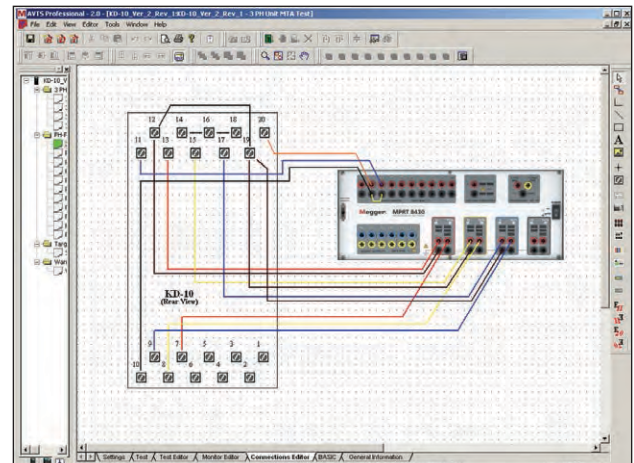

Connections Editor Screen provides relay test connections details

The Connections Images toolbar contains ten available icons for the user to define each as an image bitmap to import into the connection editor screen. This can include schematic internal diagrams of the relays, or other helpful information. Pictures of other test sets may also be used for illustration.



**Dynamic Control**

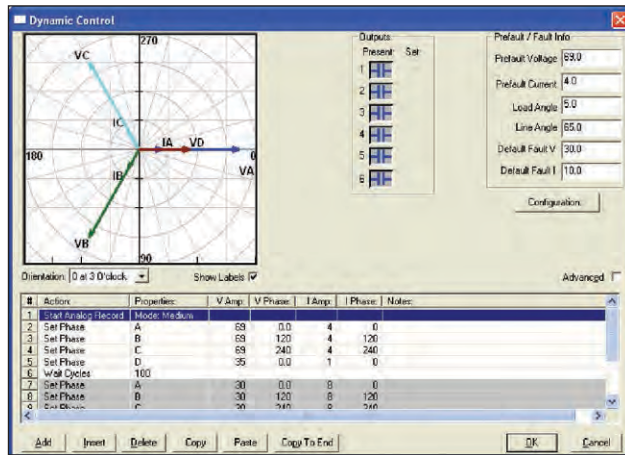

**Dynamic Control Screen**

The Dynamic Control, accessed from the Test Editor Screen, provides the user an easy means of settings up multi-state dynamic tests that are normally associated with trip and reclosing schemes or performing dynamic end-to-end tests. The figure above shows an example test setup using the Dynamic Control.

A "state" can be voltage(s), current(s), phase angle(s), timers, start and stop the analog recorder, set Boolean logic for the binary inputs, set binary output(s), or even use variables to set values. The test transitions from one state to another after a programmed time delay of either milliseconds or cycles, or after a trigger condition. In addition, the Dynamic Control allows the user to easily build harmonic waveforms with frequencies up to 1000 Hz. In conjunction with the Dynamic Control the Capture feature may be used to measure and display the output analog waveforms, binary inputs and outputs to evaluate the dynamic test results in a graphic form.

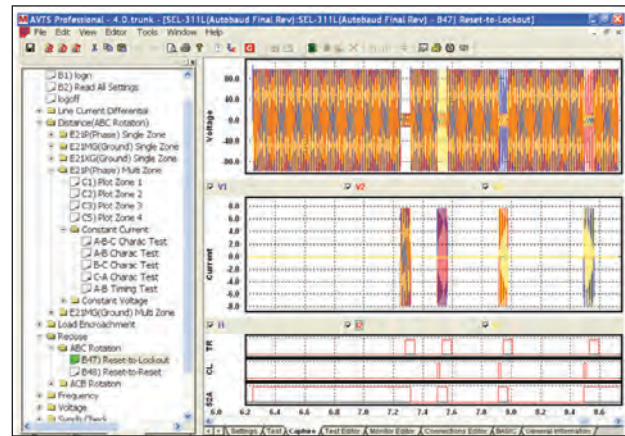

**Display of "Recorder" Capture Feature in AVTS Software – SMRT/MPRT Records Voltage and Current Outputs, and Time-Synchronous Displays with Binary Inputs and Outputs.**

**Dynamic Analog Recorder**

In association with the Dynamic Control is an analog recorder, which not only records the action of the binary inputs and outputs, but it also records the actual analog waveforms of the outputs, including DFR COMTRADE playback waveforms. For example, after running a reclosing sequence press OK to view the waveform capture screen. When the Waveform Capture screen comes up, press the Lightning Bolt button. This will load the data from the SMRT/MPRT test sets resulting in something like the waveforms shown.

The user can view the actual outputs waveforms as well as any selected binary inputs and or binary output contacts. It should also be noted that the user can record the complex waveforms that they applied using the harmonic waveform generator in the dynamic control.

**Basic Programming Tool**

The Basic Programming Tool provides a means to either import older test macros into AVTS and execute legacy test files, or to send the test system syntax commands to do special test applications not covered by the standard test modules, generic test modules, wizards, DFR playback, vector control, ramp control or dynamic control. These commands can be issued from the Basic Tool icon as part of a special test file.

**SS1 File Converter**

SS1 files are generated using Power System Simulation software programs by Electrocon® CAPE™ or Aspen One-liner®. By modeling the power system and using the SS1 files, the relay can then be tested dynamically using realistic system test scenarios. The SS1 File Converter will read the SS1 file and create a dynamic state sequence playback file. This file can be used in two ways. The first method of use is as a standard dynamic test. One application is the testing of impedance relays. By modeling the power system using simulation software, the relay can then be tested dynamically using realistic system test scenarios using actual line load conditions. The dynamic test can be used stand alone or as part of a more complex test module. The other application is as an End-to-End playback file, similar to a DFR playback file.

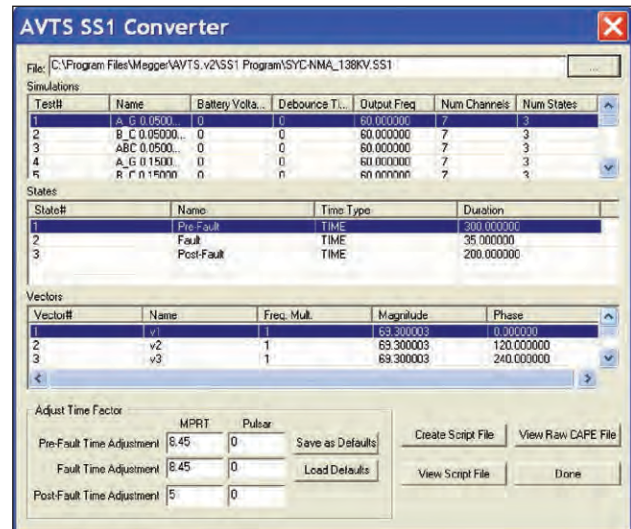

**SS1 File Converter**

**End-to-End Test Capability**

End-to-End testing usually involves GPS coordinated playback of a digital fault recorder (DFR) record, or a user- defined single or multi-state dynamic data playback by the test equipment. There are two methods to perform End-to-End tests with the SMRT/MPRT and AVTS software. One method requires **AVTS Advanced** using the **Dynamic Control** feature or use the SSI Dynamic Test and Test Editor. Using the Dynamic Control, the user can define pre-fault and fault states for single or multi-state playback, and initiate the test using the pull-down "Action" Command "Wait External" (triggers the test from a GPS programmable external trigger pulse). Another method for an End-to-End DFR Playback test is performed by using the DFR Waveform Viewer found in **AVTS Professional**. The DFR Viewer will allow the user to select the test file (a DFR playback test file) which is then loaded into the SMRT/MPRT test system. The test system then waits for a GPS trigger pulse to begin playing back the recording. Note that once a test file is created and saved, using either the Advanced Dynamic Control or Professional, that test file maybe transferred and executed by any other PC running AVTS 3.0 (or higher) **Basic, Advanced or Professional** versions, with any SMRT/MPRT unit. This provides user maximum flexibility of using any PC running AVTS, with any SMRT/MPRT unit, for end-to-end testing. A typical test equipment set up for End to End tests is shown in the following figure. It should be noted that even though the Megger Model MGTR (GPS Satellite Timing Reference) is shown, for maximum flexibility any GPS unit with a programmable output pulse maybe used for conducting end-to-end tests with the SMRT/MPRT and AVTS software.

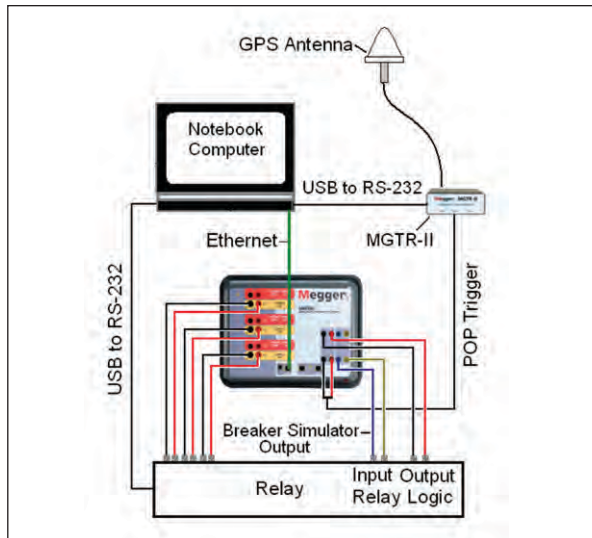

Typical End-to-End Test with MPRT

**Import Aspen Relay Database®**

In addition, relay settings may also be imported from other databases. For example, relay settings from the Aspen Relay Database® can be seen in the figure below.

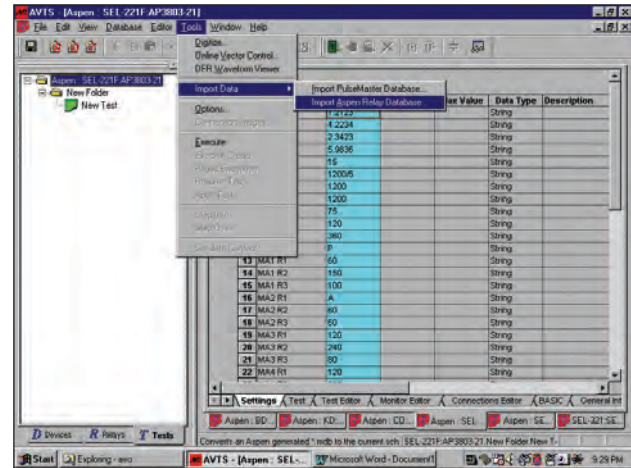

Import Relay Settings From Aspen Database

**Waveform Digitizer**

The AVTS Waveform Digitizer Tool enables the user to digitize waveforms and export them to a COMTRADE\*.cfg and \*.dat files for playback through the Test System. Waveforms from old strip chart recorders, hand drawn waveforms, and waveforms created by oscillographic functions of the modern microprocessor and numerical relays; any waveform that can be represented in a \*.bmp format can be digitized. In addition, electromechanical relay analog time curves, that do not fit numerical algorithms, can be scanned into AVTS. The digitizer can be used to create a virtual time curve to be used in the timing test. For example, AVTS software comes with numerous analog curves already digitized and ready for use.

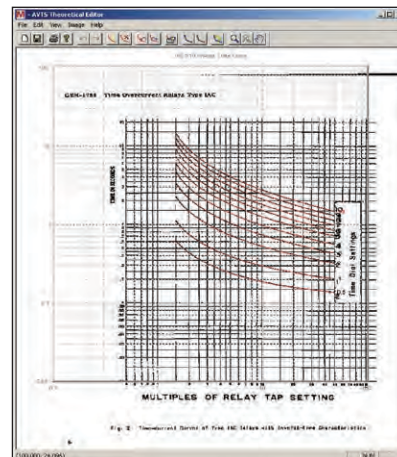

Westinghouse CO-9 Digitized Time-Current Curves



**AVTS PROFESSIONAL VERSION**

The Professional version includes all of the features previously described for the Basic and Advanced versions. It also includes special testing and editing tools for playback of Digital Fault Records or EMTP/ATP simulations that are in the IEEE C37.111 COMTRADE format. In addition, it includes the Waveform Digitizer, and the Visual Basic scripts for generating One Touch Test.

**DFR Waveform Viewer and Playback**

In addition to performing the steady-state testing, it is increasingly becoming a popular practice to perform dynamic and transient testing on protective relays. AVTS DFR Waveform Viewer has the capability of playing back transient waveform data to the Test System waveform generators. In other words, it can recreate a fault (waveforms...) recorded by a Digital Fault Recorder or simulated fault using EMTP/ATP programs. When DFR Waveform Viewer is invoked from the Tools menu, the screen called DfrWaveView dialog box will appear.

From this dialog box a user can convert digital fault recorder data, in COMTRADE format, to binary files compatible with the Test System waveform generators, select the channels and ranges to be uploaded, and upload and output the waveforms.

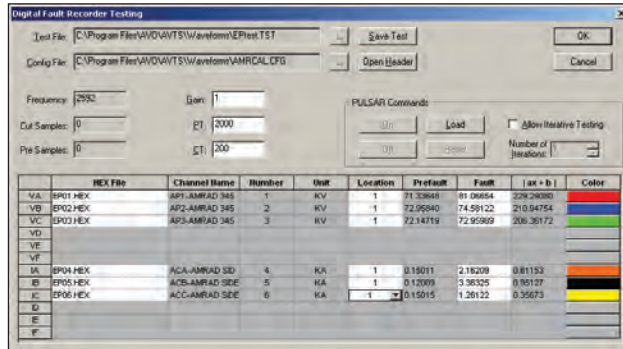

DFR Test Editing Dialog Screen

In addition, special editing capabilities allow the user to replicate the pre-fault data for as many cycles as desired to insure that the device under test is properly polarized prior to applying the fault. Timing maybe started in conjunction with the fault application, thus timing the replay event. Due to the wide operating bandwidth of the test system, there is no degrading of the recorded samples thus high fidelity of the playback waveforms is insured.

New End-to-End test capability has been added to the DFR Viewer User Interface screen, and allows GPS triggering of DFR files to be played back directly from the interface.

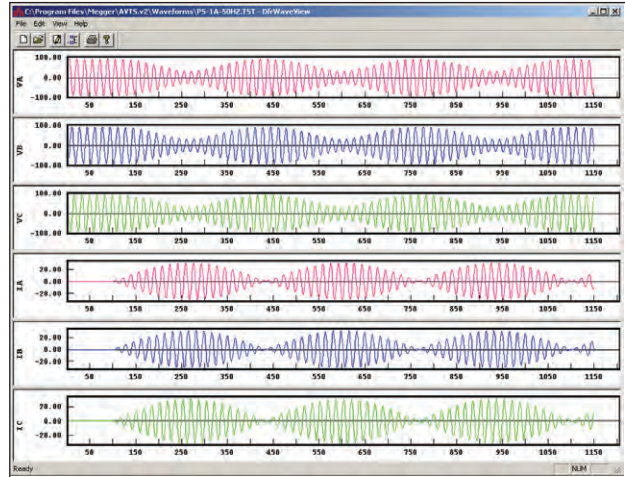

AVTS Professional Waveform Viewer Screen

**IEC 61850 Megger GOOSE Configurator**

Megger GOOSE Configurator (MGC) provides easy to use tools for testing relays and substations using the IEC 61850 protocol. It is an optional software tool available with Basic, Advanced or Professional versions of AVTS Software. The configurator provides relay test engineers and technicians the capability to import parameters from configuration files in the Substation Configuration Language (SCL) format, and/or capture GOOSE messages directly from the substation bus. All imported GOOSE messages will be unconfirmed messages. Only captured messages are confirmed messages due to the sniffing feature of the MGC. Use the MGC Merge feature to compare imported SCL and captured GOOSE messages to verify all GOOSE messages needed to perform tests. Use them to configure the SMRT/MPRT to subscribe to preselected GOOSE messages by assigning the data attributes to the appropriate binary inputs of the SMRT/MPRT. Use the configurator to assign the appropriate binary outputs of the SMRT/MPRT to publish GOOSE messages simulating circuit breaker status.

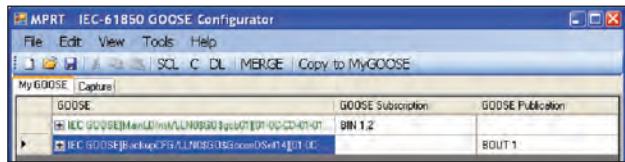

MGC 'My GOOSE' with Assigned Binary Inputs and Outputs

After the appropriate assignments of binary inputs and outputs have been made, the My GOOSE test file can be saved for reuse. This provides both manual and automatic testing of the relay using either the Touch View Interface or AVTS software. Use basic on-line test tools or standard test modules in AVTS to perform automatic tests. Use the Dynamic Control in AVTS to perform high speed trip and reclose tests, or use to perform interoperability high-speed shared I/O tests between multiple IED's.

The MGC provides mappings of Boolean and Bit Strings and/or simulation of STRuct, Integer/Unsigned, Float and UTC datasets. The SMRT/MPRT meets the IEC 61850-5 standard, Type 1A, Class P 2/3, for high speed trip and reclose simulations.

<b>ORDERING INFORMATION</b>	
<b>Item (Qty)</b>	<b>Cat. No.</b>
AVTS <b>Basic</b> Software	544244
AVTS <b>Basic</b> with IEC 61850 Megger GOOSE Configurator	1002-110
AVTS <b>Advanced</b> Software	5442455
AVTS <b>Advanced</b> with IEC 61850 Megger GOOSE Configurator	1001-037
AVTS <b>Professional</b> Software	5442465
AVTS <b>Professional</b> with IEC 61850 Megger GOOSE Configurator	1002-038
<b>Extended Software Support Program</b>	
1 to 2 users	10098
3 to 5 additional users	10097

**UK**  
Archcliffe Road, Dover  
CT17 9EN England  
T (0) 1 304 502101  
F (0) 1 304 207342

**UNITED STATES**  
4271 Bronze Way  
Dallas, TX 75237-1019 USA  
T 1 800 723 2861  
T 1 214 333 3201  
F 1 214 331 7399

**OTHER TECHNICAL SALES OFFICES**  
Norristown USA, Toronto  
CANADA, Mumbai INDIA, Trappes  
FRANCE,  
Sydney AUSTRALIA,  
Madrid SPAIN and  
The Kingdom of BAHRAIN.

**ISO STATEMENT**  
Registered to ISO 9001:1994 Reg no. Q 09250  
Registered to ISO 14001 Reg no. EMS 61597  
**AVTS\_DS\_EN\_V12**  
[www.megger.com](http://www.megger.com)  
Megger is a registered trademark

4271 Bronze Way  
Dallas, TX 75237 USA  
1-800-723-2861  
[www.megger.com/us](http://www.megger.com/us)

MEG-856/5/.2013

**Megger**<sup>®</sup>